

PRRI

PERFORMANCE RACING INDUSTRY MAGAZINE

2023 BUYERS GUIDE



INSIDE

ENGINE COMPONENTS

CHASSIS, DRIVELINE & SUSPENSION

RACING COMPONENTS, ACCESSORIES & SERVICES

MACHINERY, TOOLS & EQUIPMENT

RACE TRACK EQUIPMENT

SANCTIONING BODIES

MANUFACTURERS' REPRESENTATIVES

WAREHOUSE DISTRIBUTORS

FEATURING HUNDREDS OF
THE LATEST MOTORSPORTS
PARTS, EQUIPMENT &
SERVICES

...BUT YOUR ENGINE IS CLEAN



- Eliminate Engine Varnish
- Reduce Deposit Buildup
- Increase Performance
- Decrease Operating Temperatures
- Conquer Your Home Track





GREAT WORK!

Supported by MAHLE.

Shawn Langdon Takes It Up a Level With MAHLE!

Winning Championships at every level of drag racing requires talent, the efforts of great people, and choosing the best parts.

Shawn Langdon knew that to gain the ultimate performance with his top alcohol dragster engine, the only choice was MAHLE Performance gaskets. Engineered specific to each application, composed of the finest materials, and incorporating the most advanced manufacturing processes; MAHLE Performance gaskets are the NEW standard in sealing the most demanding performance applications. Visit us at PRI booth# 1601.



mahle-aftermarket.com

MAHLE

CONTENTS

DECEMBER 2022 | VOLUME 37, NUMBER 12

PRI

MAGAZINE

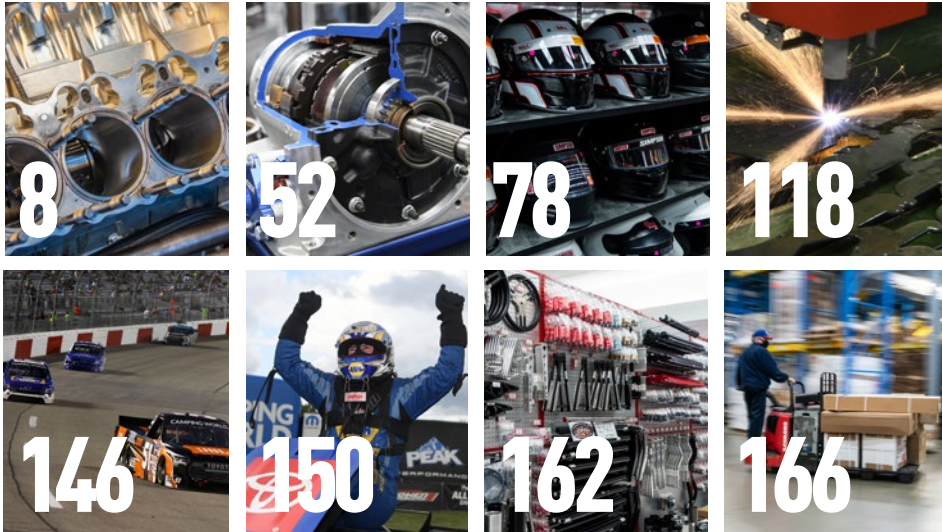

Engine Components8

State-of-the-art products—blocks, pistons, gaskets, crankshafts, cylinder heads, and more—for almost any type of powerplant.

Chassis, Driveline & Suspension52

All-new components—rearends, torque converters, clutch kits, shocks and springs, and more—for race car fabrication and parts sales.

Racing Components, Accessories & Services78

A collection of products and services—helmets, firesuits, fluids, simulators, wheels, and more—for teams, drivers, and vehicles.

Machinery, Tools & Equipment118

The latest machining and shop equipment designed to enhance cutting, honing, porting, surfacing, grinding, testing, cleaning, and more.

Race Track Equipment146

New solutions and services designed to improve operations through better track conditioning, communications, safety, and elsewhere.

Sanctioning Bodies150

A comprehensive list of organizations that regulate and coordinate the various events and series that fall under their authority.

Manufacturers' Representatives162

Leading firms that connect suppliers and customers—from the largest WDs to the smallest speed shops and engine builders.

Warehouse Distributors166

Providers of valuable storage space as well as communication tools, technical support, cataloging, and other useful services.

Suppliers Index168

Reference and contact information for hundreds of leading product suppliers representing all forms of motorsports.

DEPARTMENTS

Performance Industry Reps 183

Advertisers Index 184



PRESIDENT

Dr. Jamie Meyer

GENERAL MANAGER

Jim Liaw

EDITORIAL

EDITOR

Dan Schechner

MANAGING EDITOR

Meredith Kaplan Burns

SENIOR EDITOR / SOCIAL MEDIA

MANAGER—EDITORIAL

Christen D'Alessandro

ASSOCIATE EDITOR

Laura Pitts

CONTRIBUTORS

Drew Hardin, Bradley Iger

SALES

VICE PRESIDENT OF SALES

Warren Kosikov

INDUSTRY SALES DIRECTORS

Andrea Brake Alan Josse

Becca Butler Brian Paik

Jeff Dahlin Monica Terlouw

Scott Hartwick Willie Yee

Celina Ingargiola

SALES ASSISTANTS

Madison Danna

Marel Del Rio

Lisa Schafer

PRODUCTION

ADVERTISING COORDINATOR

Brandon Benson

ART

SENIOR ART DIRECTOR

Paul Graff

GRAPHIC DESIGNERS

John Cabral

Jeffrey Chhan

PHOTOGRAPHERS

Michael Allio, Bob D'Alessandro, Driveline Studios,

Jerry Foss NHRA/National Dragster,

Jared C. Tilton/Getty Images

ACCOUNTING

PAYABLES

Lily Huang

Performance Racing Industry (ISSN 1045 3024) is published monthly in the interest of the growth and development of the racing market, consisting of manufacturers, retailers and racing participants. *Performance Racing Industry* can be contacted at 27081 Aliso Creek Rd, Suite 150, Aliso Viejo, California 92656, 949/499-5413, Fax 949/499-0410. Periodicals Postage paid at Laguna Niguel, CA 92677, and additional mailing offices. **Postmaster:** Send address change to *Performance Racing Industry*, 27081 Aliso Creek Rd, Suite 150, Aliso Viejo, California 92656. No part of this magazine may be reproduced without written consent of the publisher who is not responsible for the unsolicited material. *Performance Racing Industry* is sent to the retailers, distributors, manufacturers and racing participants within the United States. Subscriptions are complimentary to qualified members of the racing industry. "Performance Racing Industry" is a trademark owned exclusively by SEMA © 2022 Performance Racing Industry. All rights reserved.

Printed in U.S.A.

PM # 40702022. Return Undeliverable Canadian Addresses to: Station A, PO Box 54, Windsor, ON N9A 6J6. Email: cpcreturns@wdsmail.com



SERIOUS PERFORMANCE.

SERIOUS WHOLESALE POWER BY ATECH MOTORSPORTS.

- Access to Over 1,500 Brands
- Unbeatable Service and Satisfaction
- Huge Inventory—We Stock it so You Don't Have to
- FAST, FREE Shipping—Reliable 1-2 Day Delivery
- Drop Ship Service at No Additional Fee
- We Export at Competitive Rates

PRI DEC. 8-10 | ***BOOTH #2931***



CONTACT US FIRST!

Atech Motorsports is the fastest, easiest way to access the best high performance parts and brands in the industry at wholesale prices, with real-time inventory and pricing available to you 24/7. Our four national warehouses are packed to the rafters with millions of parts from 1,500+ brands—we continually add new brands all the time—ready to ship to your door at a moment's notice or dropship directly to your customers for no extra charge. Simply tell us your needs and give us the opportunity to become your go-to parts source for all things automotive.

HIGH PERFORMANCE & RACE

LATE MODEL

TRUCK & DIESEL

JEEP & OFF-ROAD

STREET ROD & RESTORATION

**PREMIUM & STOCK
REPLACEMENTS**



AtechMotorsports.com
FOUR LOCATIONS—MILLIONS OF PARTS!

TALLMADGE, OH • MCDONOUGH, GA • SPARKS, NV • ARLINGTON, TX
800.517.1040 • 1.330.630.0888 • FAX: 1.330.630.5365

Some parts are not legal for sale or use in California or other states with similar laws/regulations. Please check your state and/or local laws/regulations. Typographical errors and errors in description or photography are subject to correction. ©2022 AUTOSALES, INC.



**Global Wholesale
DISTRIBUTOR**



- Cyl. Head & Block Surfacing
- Seat & Guide Machines
- Valve Guide Honing
- Valve Refacing

Designing & Manufacturing Patented Technologies

US 7 726 919B | US 17879818 | US 17892165



SG 5

Seat and Guide

- Cylinder Head capacity: 23" x 10" x 5"

SG 7

Seat and Guide

- Cylinder Head capacity: 32" x 10" x 6"



SG 8 Smart

Seat and Guide

SG 8

Seat and Guide

- Cylinder Head capacity: 40" x 12" x 6"



SG 8 XL Smart

Seat and Guide

SG 8 XL

Seat and Guide

- Cylinder Head capacity: 47" x 15" x 10"



Constantly-Varying Speed
US Patent - for Chatter-Free Seats!



Premium Multi-angle cutting inserts:



ROBINS...World's First (Patent applied for)
Unique revolutionary concept for V6 / V8 Cyl. Block Surfacing

****NO Precision Locators needed****
Reference from either Main Bearing Bores or Pan Rail surfaces !



Manual & Smart Surfacing



Valve Guide Honing Systems
(Patent applied for)

Anthony Usher (949) 800-7176
anthony@meccnc.com | www.meccnc.com
Eastern U.S.A & Canada

ROBINS
SINCE 1983
RobinsMachines.com



Jeff Murchison (909) 226-9922
Jeff@HopperShop.com | www.HopperShop.com
Western U.S.A

- Cyl. Head & Block Surfacing
- Seat & Guide Machines
- Valve Guide Honing
- Valve Refacing

Designing & Manufacturing Patented Technologies | US 7 726 919B | US 17879818 | US 17892165



VR10

Valve Refacing

- Premium Chuck within 0.0002" TIR
- Large Coolant
- New Concen Device



VR 5

Valve Refacing

GH8

Valve Guide Honing
Automated Honing Cycle



- Finish Valve Guides Within 0.0001"

GH90

hole to hole
Valve Guide Honing



- Fully Automatic Guide Honing Systems



RUBi SURF
Smart

Rubi Surf 1.7 Smart



RUBi SURF
Manual

Rubi Surf 1.9 Smart



RUBi SURF
Manual

Rubi Surf 1.7 Manual



SECTION

1

ENGINE COMPONENTS

Power levels are increasing exponentially, and engine combinations that were competitive just a short time ago have become increasingly commonplace thanks to advances in segments including blocks and sleeves, connecting rods, pistons, gaskets, crankshafts, valves, fuel systems, intake manifolds, cylinder heads, and many others. Here, you'll find dozens of state-of-the-art parts for almost any type of powerplant.

BAKER ENGINEERING LLC

bakerengineering.com | 616-837-8975



PRO/CAM RACING COMPONENTS

- Billet mechanical fuel pumps with free flow rate of over 200 gph
- E85/alcohol fuel compatibility
- Up to 1,200 hp with gasoline or 600 hp with alcohol fuels, 900 hp on E85
- Preset fuel pressure of 7.5, 11, or 15 psi
- No regulator needed for 7.5 psi pump
- Lightweight billet aluminum components
- Six high-flow valves; inlet and outlet can be reoriented to best fit your application
- High-performance seals
- 100% manufactured in the USA



NEO SYNTHETIC GEAR OILS

Neo Synthetic Oil
2871 Gundry Ave.
Signal Hill CA 90755

Ph: 1-562-595-7208
Email: Neooilusa@gmail.com

NeoSyntheticoil.com



"Instant Timing Knob" Racing D.U.I.

- ✓ Change your timing without loosening hold-down clamp
- ✓ Allows quick, accurate timing adjustments
- ✓ Avoid nasty hand burns
- ✓ Precise advance timing
- ✓ No timing light required

To advance or retard the timing, simply turn the knob (1/2 revolution equals 1 degree of timing; one full revolution equals 2 degrees of timing).



It's time for you to start Driving Under the Influence of more power, instant throttle response, and low-end torque!

- ✓ One-Piece Ignition System-H.E.I. Style
- ✓ Includes 50,000 Volt Coil and Dyna-Module
- ✓ Custom Tailored Advance Curve
- ✓ Allows for Wider Plug Gaps
- ✓ Each Unit Test Fired
- ✓ Simple One-Wire Hook-Up
- ✓ Maintenance Free
- ✓ Built with Oil-Impregnated Bronze Bushings
- ✓ Racing Version-10,000 RPM's



CHEVY D.U.I.

NEW! Dodge-Chrysler Racing D.U.I.

- ✓ 15 to 40 More Horsepower
- ✓ Instant Throttle Response
- ✓ Upper & Lower Bushings for Durability
- ✓ Maintenance Free
- ✓ No Spark Box Needed
- ✓ Easy Drop-In Installation
- ✓ Cleaner Engine Compartment
- ✓ Easy to Find Replacement Parts
- ✓ Racing Version-10,000 RPM's



CHRYSLER RACING D.U.I.

NEW! Mini-VIP

- ✓ 18 Volt Step-Up Regulator
- ✓ Works With Any 12V Battery
- ✓ Run a .075" Plug Gap
- ✓ Run a Richer Fuel Mixture
- ✓ Easy 3-Wire Hookup
- ✓ Prevents Voltage Drop
- ✓ Only Weighs 1 Lb!



Send \$4.00 for Complete Catalog & Prices.

Performance Distributors
HIGH PERFORMANCE & RACING IGNITION SYSTEMS
HIGH PERFORMANCE & RACING IGNITION SYSTEMS
2699 Barris Drive-Dept. SI • Memphis, TN 38132
Phone: 901.396.5782 • Fax: 901.396.5783
Website: www.performance distributors.com

*Not Legal for Sale or Use in California on Any Pollution Controlled Motor Vehicle.

CP-CARRILLO

cp-carrillo.com | 949-567-9000



CP-CARRILLO MCLAREN M840T(720S) PISTON AND ROD COMBO

- Pistons available with skirt and crown coatings
- Connecting rods made from forgings to enable proper grain flow and guarantee strength and durability
- Designed with Honda K-series bearing
- Both piston and rod designed for 1,600 hp
- Proudly manufactured in the USA from locally sourced materials



BIG POWER ADDER BIG BLOCK CHEVROLET LINE OF PISTONS

- BBC power-adder line of pistons includes double force-fed pin oilers with reservoir groove, precision pin fitting and custom cam profiles
- 10.5:1 compression and is geared toward high-boost, high-horsepower applications
- We currently offer three bore sizes: 4.500, 4.530 and 4.600
- Proudly manufactured in the USA from locally sourced materials



VR30DDTT NISSAN 400Z AND INFINITI Q50/60 PISTON AND ROD COMBO

- Brand new developed pistons available for the VR30DDTT in the new Nissan 400Z and Infiniti Q50 and Q60
- Includes all our company's engineering enhancements, PVD rings, direct injection pocket for efficient fuel burn 1,300 hp, VR30DDTT
- Standard bore, 10.3:1 compression
- Proudly made in the USA from locally sourced materials



BULLET CHEVROLET LT1 PISTONS AND ROD DROP-IN COMBO

- Designed for power adder 10.5 pistons
- Available in stock bore 4.065, stock stroke 3.622, combined with 6.125 Bullet connecting rods
- Good up to 1,200 hp
- Extensive R&D done to find optimum piston skirt shape, which will seal cylinders and reduce harmonics in the bore better than ever before
- Made in the USA from locally sourced materials

DELTA PAG

deltapag.com | 212-203-2912



MONO-CORE ALUMINUM RADIATORS

- Newly designed aluminum radiator cores by Delta PAG use only one extra-wide tube vs. multiple smaller tubes
- Unique Mono-Core design increases air velocity effectively increasing heat dissipation
- More space for proper shrouding and fan assembly
- One row is better than a four-row



BRUSHLESS WATER PUMP

- 60 gallons per minute (227 liters per minute)
- Variable speed acts like a virtual thermostat
- Removal of conventional thermostat increases top-end flow rates
- Brushless so it will last for +50,000 hours; last pump you're going to buy
- Inlet single AN20, outlets dual AN12



BRUSHLESS COOLING FANS

- More airflow up to 4,100 cfm
- Thinner at only 2.70 inches
- Soft Start eliminates power spikes
- Variable speed runs extremely efficiently
- Unique designed small brushless motor packs a punch
- 12, 14, 16, and 18 inches



DIGITAL TEMPERATURE CONTROLLER

- Dual-channel digital temperature/speed controller
- Set on and off settings for two fans or pumps
- Increases and decreases speed of fan or pump via PWM outputs
- Ridiculously accurate at 1% temperature
- Bright 3-inch display, use as your primary temp gauge

Behrent's
Performance Warehouse

— WHAT WE DO... —

WHOLESALE
DISTRIBUTION

— WHAT SEPARATES US FROM THE PACK... —

THE TOP BRANDS

THE LATEST PRODUCTS FROM INDUSTRY LEADERS

MEGA INVENTORY

WHAT YOU NEED, WHEN YOU NEED IT

RELIABLE SHIPPING

SAME DAY SHIPPING - AIR, GROUND, FREIGHT

TECHNICAL SERVICE

QUESTIONS? OUR SALES TEAM IS COMPRISED OF RACERS - NOT ORDER TAKERS!



— THE EXCLUSIVE HOME OF —

PANELfast

THE LEADER IN
QUARTER-TURN
FASTENERS &
MUCH MORE!



Behrents.com

TOLL FREE: 877-372-2348



LOCATED IN FLORIDA, NY | SALES@BEHRENTS.COM



FIND OUT WHY THE MOST KNOWLEDGEABLE ENGINE BUILDERS AND RACERS HAVE MADE THE SWITCH TO CAM MOTION CAMSHAFTS

ADVANCED CAMSHAFT DESIGN FOR DOMESTIC V8 ENGINES:
LS, LT, GEN 3 HEMI
SBC, BBC, SBF



BOOTH #2307

CAMMOTION.COM

SECTION 1

ENGINE COMPONENTS

JMS PERFORMANCE GROUP



jmschip.com | 601-766-9424



CD-1 SUPER SPEEDWAY - LATE MODEL RACING IGNITION SYSTEM

- Plug-and-play capacitive discharge racing ignition system for Late Model crate engine racing
- Part number 6000-6701K
- Approved racing ignition system: Southern Super Series, CARS Super Late Model Tour, SPEARS Southwest Tour Series
- 135 mJ spark energy, encapsulated construction, highly resistant to vibration and shock



JMS PERFORMANCE GROUP SMART SPARK—TRANS-AM SERIES TA2 LS IGNITION SYSTEM

- Complete kit with wiring harness
- TA2 ignition system for Chevy LS engines
- Part number TA2SSLS-K
- Supports approved TA2 GM LS racing engines (carbureted LS engines with 58-tooth crank trigger)
- Pre-programmed with approved TA2 ignition timing advance tables, sealed for the TA2 racing series



FUELMAX—FUEL PUMP BOOSTER

- Plug-and-play—Dodge, GM, Ford
- Boosts fuel pump voltage equals more fuel pump flow
- 22-volt max output
- User adjustable
- Support up to 1,000-hp single pump and 1,300 hp with dual pumps
- Direct wire-in version available for racing



TRACTIONMAX—SLIPPING AIN'T WINNING

- Optimize acceleration and traction and increase throttle response
- Most vehicles supported
- Simple install and setup
- Includes dual adjustment dial
- Compatible with factory and aftermarket tuning
- Designed and assembled in the USA

MELLING PERFORMANCE

melling.com | 517-787-8172



HP VALVE SPRING KITS FOR GM LS ENGINES

- 12 kit part numbers available
- Kits available with either titanium or chromoly retainers
- Designed and manufactured by Melling in our state-of-the-art facility in the UK



HP VALVE SPRING SETS FOR GM LS ENGINES

- Six part numbers available
- Designed and manufactured by Melling in our state-of-the-art facility in the UK
- Download our mini Valve Spring Catalog at Melling.com



HP HEMI CAMSHAFTS

- Four part numbers available
- Low to midrange torque and horsepower
- Works with stock or modified engine
- Made in the USA



HP HEMI LIFTERS

- Cold forged steel body, heat-treated for exceptional wear resistance
- Precision-ground needle bearing with high chromium steel axle for long life and minimal friction
- Cold forged extra-long piston, precision ground and fitted for controlled leak down and pump up

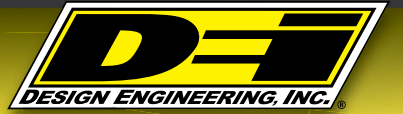

ADVANCED TURBO PROTECTION

GEN3 ONYX BLACK TURBO SHIELD

- SILICONE COATED BASALT
- SILICA INSULATION
- STAINLESS STEEL & SILICONE INNER LAYER
- STAINLESS STEEL MESH INNER COVER
- 4-TIMES THE SEAM STRENGTH

800.264.9472

DesignEngineering.com



Dealers & Distributor Inquiries Welcome

Split Mono Leaf SPRINGS



Marc Noln's 1980 Chevrolet Camaro Z28 Calverts, Calvert Split Mono Leafsprings, CR Series Rear Shocks

Calvert's performance Split Mono Leafsprings provide increased spring rate over stock springs. This slows down rate of separation for faster and more consistent 60' times. Helps plant the rear without unloading. Assembled and ready to install, the unique parabolic design distributes stress along the length of the spring and can withstand over 2,500 HP.

burnin' up the track
CALVERT RACING

ASK A TECH:

661-728-9600

Hours: M-F 8am-4:30pm PST

CalvertRacing.com



WHEN COMMUNICATIONS IS KEY...TURN TO... TURN 2

- Communication Systems
- Helmets • Tents • Trailer Curtains
- Tool Box Covers



Official Radio Provider for the NMCA Muscle Car Nationals and NMRA Nationals Series



Racing Communications - Custom Pit Mats and Trailer Curtains
www.Turn2RC.com

302-362-2441
www.Turn2RC.com **PRISHOW BOOTH 4245**

MELLING PERFORMANCE

melling.com | 517-787-8172



HP CAMSHAFTS FOR GM LS ENGINES

- Hydraulic roller performance camshafts
- 12 LS performance camshaft options available
- Three-bolt non VVT option
- Non AFM engines



HP LIFTERS FOR GM LS ENGINES

- Multiple part numbers available
- Cold forged steel body, heat-treated for exceptional wear resistance
- Precision-ground needle bearing with high chromium steel axle for long life and minimal friction
- Cold forged extra-long piston, precision ground and fitted for controlled leak down and pump up

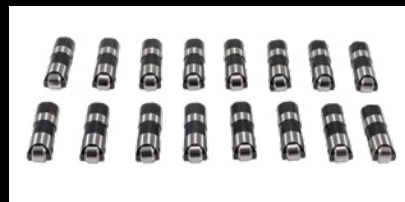

HP LIFTERS FOR SMALL BLOCK GM

- Three part numbers available
- High-flow, disc-style, quick-reacting check valve for better reaction at higher rpm
- Precision oil metering assuring proper oiling to the rocker arms



HP LIFTERS FOR SMALL BLOCK FORD

- Cold forged steel body, heat-treated for exceptional wear resistance
- Precision-ground needle bearing with high chromium steel axle for long life and minimal friction
- Cold forged extra-long piston, precision ground and fitted for controlled leak down and pump up

NORTHERN RADIATOR

northernradiator.com | 800-328-8900

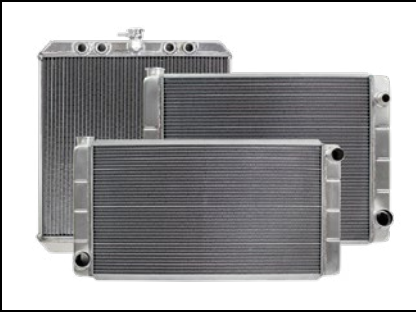

RACE RADIATORS

- High-performance aluminum radiators
- Up to 24% improvement in heat transfer over other brands
- 16-inch and 19-inch styles with two rows of 1-inch high-capacity cooling tubes
- Single-, double-, and triple-pass options for optimum cooling
- Louvered cooling fins for better heat dissipation



INTERCHANGEABLE RADIATORS

- Cover a large variety of dirt and asphalt racing applications with minimal inventory/SKUs
- Interchangeable inlet or inlet/outlet fittings with threaded connections
- All-aluminum, two rows of 1-inch tubes, single or double pass styles
- Multiple hose connection options



THE BOSS 3-ROW RADIATORS

- Three rows of 1-inch tubes provide 30% more cooling capacity than any brand of two-row 1-inch tube radiator
- Extra rows of cooling for demanding applications
- Finished with typical GM hose connections or as custom kits
- Machined billet aluminum SAE compliant filler neck and 1/4-inch plugged NPT port



ELECTRIC & ENGINE-DRIVEN FAN SHROUDS

- Standard performance, high-cfm, brushless electric, or engine-driven shrouds to fit your application
- Brushless fans provide better cooling and no amp spikes in a smaller space
- Shrouds for cross- or down-flow radiator mounting for maximum cooling

CUSTOM TUBE BENDING AND FABRICATION

MANDREL BENDING

- STAINLESS STEEL
- ALUMINUM
- MILD STEEL

**FROM 1/4" OD TO 6" OD
WE BEND IT ALL**

PURCHASE TUBE SOLUTIONS FOR THE MASTER FABRICATOR

MANDREL BENDS - COLLECTORS - FLANGES
FLEX PIPES - O2 SENSOR - V BAND

PRIVATE LABELING AVAILABLE

**5462 DIAZ STREET
IRWINDALE, CA 91706**

**TEL: 626 939-9000
FAX: 626 939-9006**

WWW.PTBTUBE BENDING.COM



#IAMPRI

PRI FUELS THE PASSION
FOR MOTORSPORTS.

WE BUILD, PROMOTE,
AND PROTECT THE
RACING COMMUNITY.



WINNING TOGETHER

Learn more at
performanceracing.com/membership



TURBOSMART PTY LTD.

turbosmart.com | 909-476-2570



PNEUMATIC STRAIGHTGATE50

- New in 2022, this pneumatically actuated butterfly-style external wastegate is available with either boost-based or vacuum-based actuators
- Self-balancing zero-offset butterfly valve
- Unparalleled tuning window: five times base spring pressure
- Designed and validated to 1,800 deg F (1,000 deg C) EGTs
- 360-degree 60-mm V-Band fitment
- Clock-able billet actuator and bracket



ALL NEW TURBOCHARGER OIL PRESSURE REGULATOR

- Debuted in 2022, this all-new, patent-pending OPR features an inline, return-less design providing rock solid oil pressure for your turbocharger with a simple inline install and built-in oil filter
- Inline, return-less regulator design
- Built-in 44 micron SS mesh filter
- Laminar flow valve design
- Suits most turbocharger systems



VIWG VACUUM-BASED UPGRADED ACTUATOR SERIES

- New in 2022, the vIWG Vacuum-Based Actuator Series for internally wastegated turbochargers provides increases in control and boost stability via a billet aluminum body, silicon-Nomex diaphragm
- Vacuum-based wastegate actuator control
- Available in single- and twin-port for boost assist
- Multiple actuator sizes and springs
- Vehicle specific, turbo specific or universal
- Billet aluminum construction



ALL NEW PRO M FPR FUEL PRESSURE REGULATORS

- New Pro M Fuel Pressure Regulators to suit mechanical fuel pumps for industry-leading 1:1 ratio and response with all known fuels
- Available in AN10 and AN12
- Suitable for all fuel types
- 1:1 class-leading ratio and response
- Adjustable Base Pressure (50-100 psi)
- Suits mechanical pump EFI systems
- Onboard Sensor Port

VORTECH SUPERCHARGERS

vortechsuperchargers.com | 805-247-0226



ALL NEW V-13 94C RACE SUPERCHARGER

- Designed for engines built with extreme boost demands, Vortech's new, compact V-13 94C Race Supercharger head unit supports up to 1,475+ hp and 30+ PSI
- Billet 6061 gearcase and cover, proprietary billet impeller, internal oiling and bearing design, all help the V-13 94C supercharger pack a very powerful punch for its size



BIG BLOCK CHEVY V-30 RACE SUPERCHARGER MOUNTING BRACKET ASSEMBLY

- Billet mounting bracket assembly engineered to install the respected V-30 Centrifugal Supercharger onto modified big block Chevy engines
- Utilizing twin-plates for mounting and hard anodized 50-mm cog pulleys, 1,700–2,800-hp level kits are available for BBC engines with 9.8 and 10.2 deck heights



LS SWAP 5TH GEN CAMARO SS FEAD SUPERCHARGER

- LS swap supercharger kit capable of supporting up to 1,200 hp based on the 5th Gen Camaro SS FEAD
- Includes the V-7 YSi head unit, mounting brackets and option of either 10-rib pulley or 50-mm cog drive components



LS V-30 RACE SUPERCHARGER MOUNTING BRACKET ASSEMBLY

- Mounts the V-30 supercharger onto Chevy LS engines using a billet mounting bracket assembly with kits ranging from 1,400+ hp up to 2,800+ hp
- Billet aluminum twin-plate construction
- Fits 4.8L through 7.0L LS engines
- Compatible with most aftermarket LS cylinder heads and blocks

BECAUSE
WAITING
ISN'T
WINNING.



GET BILLET PARTS
AND SUPPLIES WITHIN
WEEKS - NOT MONTHS
(OR YEARS).



Energy Manufacturing Ltd.
(419) 355-9304
energymanufacturing.com

Made in the USA



AERO EXHAUST AERO TURBINE PERFORMANCE MUFFLER

- Patented airfoil cone technology
- 100% 304 stainless steel
- Mirror polished finish
- AERO Exhaust stamped logo
- Fully welded construction
- Increased power and torque
- Available in 2.5-inch – 5.0-inch diameter
- Also available with a built-in resonator

Contact: 801-301-0408
aeroexhaust.com

AEROMOTIVE INC. 2011–2017 MUSTANG (S197 AND S550), 2018–2020 (GT/ ECOBOOST) IN-TANK

BRUSHLESS PUMP MODULES

- Direct drop-in for OEM tank
- Single pump simplifies wiring and plumbing over multi-pump configurations
- Brushless motor with remote mount controller for reduced amp draw
- Utilizes patented Aeromotive Jet Siphon in conjunction with OEM siphon pickup
- Integrated 100-micron pre-filter
- True Variable Speed Controller
- -08 ORB outlet and return ports
- Fuel level sender bracket to utilize OEM fuel level sender

Contact: 913-647-7300
aeromotiveinc.com

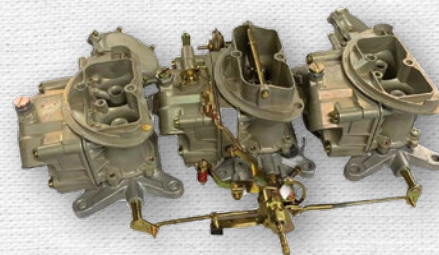

ALLSTATE CARBURETOR CLASSIC CARBURETOR RESTORATION

- Recolored, replated, remanufactured, and restored to OE appearance and calibration

Contact: 631-234-8327
allcarbs.com



ALTRONICS INC. POWERLITE PRO SERIES LITHIUM BATTERY

- Extremely lightweight
- Advanced battery management system controls all battery functions
- Protects from under/over charge, short circuit, overheating, and low voltage cutoff
- Full four-year warranty

Contact: 847-923-0002
altronicsinc.com



BAT INC./MOCAL USA REMOTE FILTER MOUNT WITH THERMOSTAT

- Mocal remote oil filter stand/mount with oil thermostat
- Simplifies plumbing by incorporating oil thermostat into remote filter mount for use with oil coolers

Contact: 941-355-0005
batinc.net



BEHRENT'S PERFORMANCE WAREHOUSE BSC LIGHTWEIGHT TRIPLE PASS ALUMINUM SPRINT CAR RADIATOR

- 20-1/2-inch height x 17-1/2-inch width x 2-inch thick
- Four AN 10 ports
- Weighs 9.7 pounds empty
- Includes mounting tabs

Contact: 845-651-7389
behrents.com

REDUCE TEMPS AND INCREASE FLOW

GM 10L80 TRANSMISSION

10
SPEED
10L80

4 EXTRA QUARTS ▶

Heavy-Duty Cast Aluminum DEEP 10L80 Transmission Pan

PPE's Heavy-Duty DEEP 10L80 Transmission Pan holds an extra 4 quarts of fluid and is cast from high-quality A356.0-T6 aluminum alloy for strength and optimal heat dissipation.

Available in Raw(128051100), Brushed(128051110) or Black(128051120) powder coat finishes.

Applications: 2019+ GM Silverado/Sierra 1500 with 10L80 Transmissions



3X MORE HEAT DISSIPATION

Bar and Plate Transmission Fluid Cooler 10L80/8L90 Transmission

A bigger effective cooling area and thicker core enable the PPE cooler to draw 200% more heat from your transmission fluid compared to the factory cooler. (124067000)

Applications: 2019+ GM Silverado/Sierra 1500 with 10L80/8L90 Transmissions



Transmission Fluid Thermal Bypass Valve - 10L80

Add another measure of protection and increase fluid flow to the transmission cooler. (125069000)

Applications: 2019+ GM Silverado/Sierra 1500 with 10L80 Transmissions



PACIFIC PERFORMANCE ENGINEERING

PPEpower.com | 725.238.2002



BILL MITCHELL PRODUCTS/BMP ALUMINUM ENGINE BLOCKS

- 357T6 aluminum, billet 1045 four-bolt steel splayed main caps
- Replaceable ductile sleeves
- Priority main oiling
- ARP main cap studs
- Available in: LS, small block Chevy, big block Chevy, big block 409 Chevy, small block Ford, Gen II Hemi and Wedge

Contact: 386-957-3009
billmitchellproducts.com

BILLET CONNECTION - CLEAR VIEW FILTRATION CLEAR VIEW FILTRATION'S NEW BILLET DRY SUMP TANKS

- Billet Connection and Clear View Filtration have developed a billet dry sump tank with the patented see-through filter assembly on the top of the tank
- This tank is completely machined with no welds inside or out
- Tank has superior venting and baffle system that is mounted to the tank top for easy maintenance and cleaning

Contact: 509-467-7584
billetconnection.com

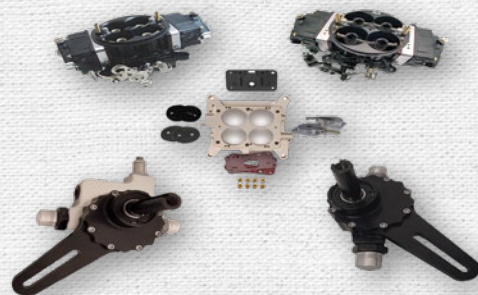

BLP RACING PRODUCTS LLC BLP BELT DRIVEN FUEL PUMPS

- Belt-driven fuel pumps available in two models: one with an internal fuel by-pass system and one to be used with an external system
- Can be used on gasoline and alcohol engines to avoid the high fuel pressure spike and battery drain of electric pumps
- Uses less than 1 HP on an 800 HP engine

Contact: 407-422-0394
blp.com



BOOSTLINE DIESEL CONNECTING RODS FOR CUMMINS & DURAMAX

- Patented three-pocket design provides 60% improvement in bending strength and 20% tensional stress reduction compared to common H-beam designs
- Forged from ultra-strong 4340 steel
- Standard-equipped with 12-mm ARP 2000 fasteners providing 23% more clamping force over 7/16-inch ARP 2000 fasteners
- Duration tested on the dyno at over 2,000 lb-ft of torque

Contact: 800-321-1364
boostlineproducts.com



BRILLE BATTERY LLC GREENLITE G-SBS30C LITHIUM BATTERY AND CHARGER COMBO

- 6.6-pound lithium upgrade for Odyssey PC950 and SBS30 AGM batteries at less than one-third of the weight
- Provides more cranking power and greater capacity while lasting up to five times longer
- Includes 6-amp lithium charger

Contact: 941-312-5047
brillebattery.com



BRASWELL CARBURETION CRATE CARBURETOR

- Five models sized and calibrated for each of the 602 and 604 engines
- Gas, 110, CHP, E85, ethanol, and methanol
- Type 3 anodizing on all metering blocks and bowls for alcohol-based fuels

Contact: 520-579-9177
braswell.com

ARP
automotive Racing products

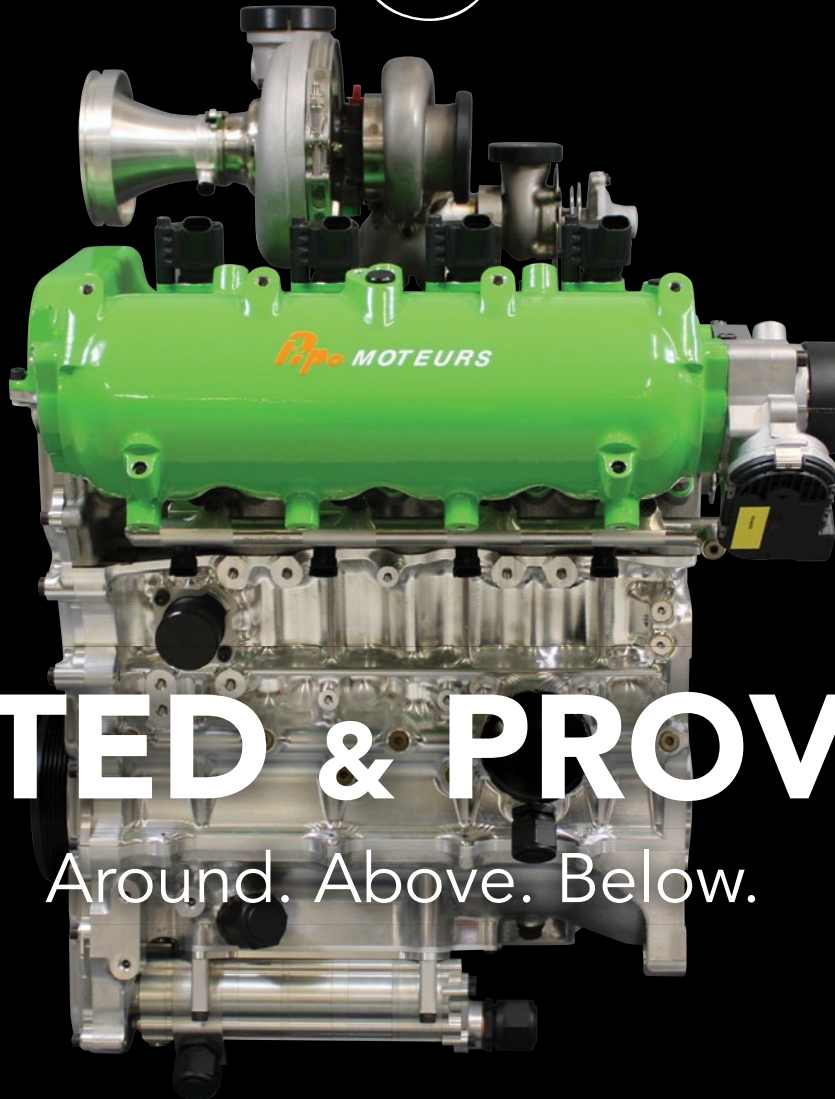

TESTED & PROVEN

Around. Above. Below.

*Pipo Moteurs H2 hydrogen internal combustion engine
utilizes custom and off-the-shelf ARP fasteners.*

ARP Fasteners are tested and proven in the most demanding environments on Earth...and beyond.



All ARP fasteners are
manufactured entirely
in our own facilities
in Southern California
and raced all over
the world.

5,000 catalog items and specials by request

Special Orders +1.805.525.1497 • Outside the U.S.A. +1.805.339.2200

1.800.826.3045 • arp-bolts.com



BRIAN TOOLEY RACING
BTR GEN V 230 CAMSHAFT
WITH VVT LIMITER

- Developed in-house using BTR designed lobes
- Intended for use as a MAX EFFORT WT cam, in combination with aftermarket milled and ported cylinder heads, while using an aftermarket throttle body and intake manifold
- Power figures of 730+ hp in a SBE application when used in conjunction with BTR valvetrain components

Contact: 888-959-8865
briantooley racing.com

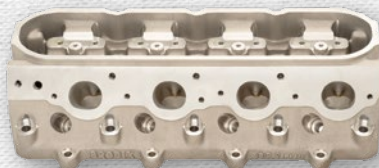

BRODIX INC.
BR 5.3 CYLINDER HEAD

- LS compatible
- 13.5° valve angle
- Intake port flows 298 cfm
- Exhaust port flows over 180 cfm
- 2.020/1.550 valve sizes
- Out-of-the-box horsepower
- Thick deck for nitrous/blown applications
- Toughest castings in the business

Contact: 479-394-1075
brodix.com



C&S SPECIALTIES INC.
C&S AEROSOL BILLET
BLOW THRU CARBURETOR,
LOG AND BYPASS

- 48 years of proven performance
- Built on our technology, research and development
- Wet flow tested
- Separate boosted and non-boosted tuning circuits
- Adjustable dual booster reference power valves
- Built in the USA

Contact: 636-723-4996
candsspecialties.com



CALLIES PERFORMANCE
PRODUCTS INC.
MAGNUM 8
COUNTERWEIGHT SMALL
BLOCK FORD CRANKSHAFT

- Average weight 48–55 lbs.
- Stroke availability from 2.600–4.500 inches
- 2.100, 2.000, 1.888, and 1.825 rod journal diameters
- 351 Cleveland or 302 Ford type main diameters
- Perma case deep nitride heat-treatment

Contact: 419-435-2711
callies.com



CANTON RACING PRODUCTS
25-500 SERIES BILLET
SPIN-ON OIL FILTERS

- Designed to provide superior filtration, flow, and durability
- Full synthetic element provides depth filtration, which means no bypass needed
- Moisture resistant, inspectable, and rupture proof housing

Contact: 203-481-9460
cantonracingproducts.com



CHAMP PANS
PRO1100K0

- Aluminum wet sump oil pan
- Small block Chevrolet years 1957–1985 with the two-piece rear main seal
- Used in circle track racing
- Includes louvered windage tray for increased horsepower and better oil control

Contact: 715-834-7748
champpans.com

2023 NEW PRODUCTS

NEW

"AS CAST"

BR 5.3™

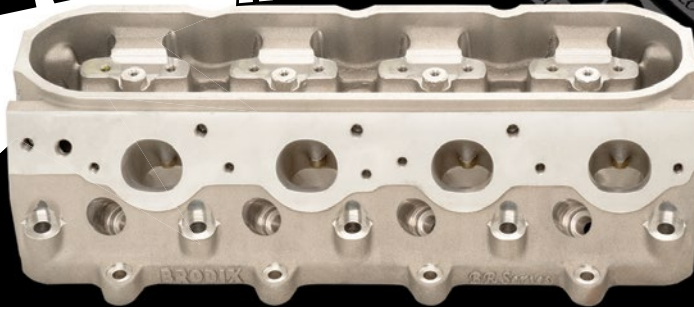

- LS Compatible
- 13.5° Valve Angle
- Intake Port Flows 298 cfm
- Exhaust Port Flows Over 180 cfm
- 2.020 / 1.550 Valve Sizes
- Out-of-the-Box Horsepower
- Thick Deck for Nitrous/Blown Applications
- Toughest Castings in the Business

Valve Covers

VC 100™ Series Small Block & VC 200™ Series Big Block

- BRODIX® Sheet Metal Valve Covers
- Ultra Thick .500" Railing for Maximum Sealing
- Includes Installation Hardware
- Maximum Clearance for Most Stud Girdles
- Clears Shaft System Rockers
- Weldable Material for Additional Fittings

NEW

**LASER ETCHED
CUSTOMER LOGO
OPTIONS AVAILABLE
FOR VALVE COVERS!**

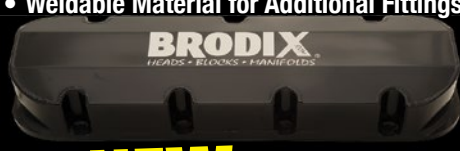

NEW CRANKSHAFTS



LS BILLET CRANKSHAFTS

PART #	STROKE	MAIN	WEIGHT	ROD JOURNAL	BALANCE	MINIMUM ROD LENGTH	PER
BR C34636226125-8	3.622	2.559	57	2.099	1780	6.125	1
BR C34640006125-8	4.000	2.559	57	2.099	1780	6.125	1

SMALL BLOCK CHEVROLET COMPATIBLE FORGED CRANKSHAFTS

PART #	STROKE	MAIN	WEIGHT	ROD JOURNAL	BALANCE	MINIMUM ROD LENGTH	PER
BR C35037506000LW	3.750	350	46	2.100	1820	6.000	1
BR C35038756000LW	3.875	350	46	2.100	1820	6.000	1
BR C35040006000LW	4.000	350	50	2.100	1820	6.000	1
BR C35041256000LW	4.125	350	48	2.100	1820	6.000	1

BIG BLOCK CHEVROLET COMPATIBLE FORGED CRANKSHAFTS

PART #	STROKE	MAIN	WEIGHT	ROD JOURNAL	BALANCE	MINIMUM ROD LENGTH	PER
BR C45442506385	4.250	2.750	76	2.200	2300	6.385	1
BR C45443756385	4.375	2.750	76	2.200	2300	6.385	1
BR C45445006385	4.500	2.750	77	2.200	2400	6.385	1

BIG BLOCK CHEVROLET COMPATIBLE BILLET CRANKSHAFTS

PART #	STROKE	MAIN	WEIGHT	ROD JOURNAL	BALANCE	MINIMUM ROD LENGTH	PER
BR C45442506385B	4.250	2.750	77	2.200	2300	6.385	1
BR C45443756385B	4.375	2.750	78	2.200	2300	6.385	1
BR C45445006385B	4.500	2.750	77	2.200	2400	6.385	1
BR C45446256700B	4.625	2.750	77	2.200	2400	6.700	1
BR C45447506700B	4.750	2.750	78	2.200	2400	6.700	1



Visit
www.brodix.com/shop
to order BRODIX®
merchandise!

Sign up at
www.brodix.com/signup
to hear the latest
and
greatest news
from BRODIX®!

www.brodix.com



PROUDLY MADE IN
THE USA!



301 MAPLE AVE. P.O. BOX 1347 MENA, AR 71953
(479) 394-1075 • FAX: (479) 394-1996



COMP CAMS EVOLUTION HYDRAULIC ROLLER LIFTERS WITH HYDRAULIC CARTRIDGE TECHNOLOGY (HCT)

- Patented HCT uses a self-contained hydraulic cartridge with reduced oil volume to deliver consistent bleed rates
- HCT and proprietary methods ensure unparalleled precision and longevity
- Stiff lifter body reduces body distortion to ensure consistent performance
- Hydraulic element is serviceable, allowing anyone to rebuild

Contact: 901-795-2400
compcams.com



DART MACHINERY LTD.

DART LS NEXT2 ENGINE BLOCK OFFERINGS

- Skirted and non-skirted design options
- Standard and raised cam height options
- Priority main oiling system
- Available in deck heights from 9.240 inches, 9.450 inches, 9.750 inches
- Cylinder barrels extended .375 inches at the bottom
- Extra thick decks ensure reliable head gasket seal
- Blind 1/2-inch head bolt holes
- Scalloped water jackets increase flow around cylinders for better cooling

Contact: 248-362-1188
dartheads.com



DARTON SLEEVES DARTON MID FOR NISSAN VR30

- New MID wet sleeve kit for the Nissan VR30DDTT Kit will convert the block to a closed deck configuration
- Bore range of 86 mm to 90 mm max
- Made from our DD12017 Top Fuel material

Contact: 760-603-9895
dartonsleeves.com



DAYCO PRODUCTS, LLC DAYCO SUPERCHARGER BELT

- Engineered for late model high-performance supercharged street cars like ZR1 Corvette, Shelby Mustang, and SRT Hellcat applications
- Launched after extensive testing with DSR and Watson Racing
- Aramid fiber loaded EPDM construction and high stiffness PET cords eliminate belt stretch
- Extreme durability and reduced slip under high-boost conditions
- Imprinted with Dayco Racing logo

Contact: 248-404-6537
daycoaftermarket.com



DAYTONA TWIN TEC M8F1 - RACING ECU FOR 2017-2021 HARLEY DAVIDSON

- Supports the Milwaukee-Eight Harley Davidson engine
- Fully programmable stand-alone racing ECU
- Built in data logging

Contact: 386-304-0700
daytona-twintec.com



DERALE PERFORMANCE BRUSHLESS ELECTRIC FAN POWERPACKS WITH PWM CONTROL

- Derale's new 4400 CFM dual brushless shrouded powerpacks feature state-of-the-art brushless electric fans married to their high-performing welded aluminum shrouds
- The kit includes a 185° PWM Fan Control with full plug-and-play wire harness

Contact: 323-266-3850
derale.com

BR Motorsports

30 YEARS OF SERVICING THE RACING INDUSTRY!

MSD MAG REPAIR

Home Of The **Black Magic** Pro Mag Series

- Black Magic Conversions
- Complete System Dyno Load Testing
- Amperage & Magnet Upgrades
- Amperage Conversions
- Factory Authorized Repair Service
- Control/Spark Box Repairs
- Rotation Changes
- Circuit Board Rebuilds/Repairs
- Coil Replacements
- Factory Authorized Upgrades
- System Blueprinting
- Fire Damage Repairs
- Generator Servicing & Rebuilding



THE ONLY MSD MULTI TEST FACILITY IN THE USA!!

Generators, Point Boxes, Control Units, Connectors, Wire Harnesses & Every Other Part Your Pro Mag System will ever need! When You have BR Motorsports service or repair do your MSD Magneto System the job will be done correctly, honestly and in a timely manner. No If And Or Buts!!



PRI
TRADE SHOW

EXHIBITOR
BOOTH# 1909

Stop By And
Check Out Our
2023 Upgrades

ENGINE BUILDER PROGRAMS • QUICK TURN AROUND • UPS DAILY DOMESTIC OR INTERNATIONAL

1-800-328-3333 • BRPROMAG.COM

2216 Mineral King Ave. Visalia, CA 93292



DIAMOND PISTONS AUDI/LAMBORGHINI FSI 5.2L V10 PISTON SERIES

- 3D milling on piston crowns for ready-to-install finish
- Offset pins for quiet operation
- Moly skirt coating for friction loss and skirt wear protection
- Side gas ports for better ring seal
- Top ring down dimension: .230 inches
- Premium H13 .200W wrist pins chamfered for round wire locks included
- Premium 1.2-mm x 1.2-mm x 2.0-mm ring package included

Contact: 586-792-6620
diamondracing.net



EDELBROCK LLC VRS-4150 RACE AND PERFORMANCE CARBURETORS

- One-piece, cast aluminum main body—up to 950 CFM rating
- Billet four fuel circuit metering blocks for precise tuning capability
- Split high-speed main circuit allows greater bleed control at high rpm
- Intermediate circuit on both primary and secondary bores
- Larger capacity fuel bowls are baffled to control fuel slosh

Contact: 800-416-8628
edelbrock.com



ENGINE ICE - KOST USA ICE WATER RACING COOLANT

- Maximize horsepower and run cooler for longer with superior heat transfer
- 10 times better corrosion protection than the competition
- Superior protection of rubber hoses and seals
- Meets ASTM1334 limits for D3306, 2EH-free

Contact: 312-771-3551
engineice.com



ENGINE PARTS GROUP INC. ENGINE PRO PERFORMANCE COATED ENGINE BEARINGS

- All the high-end features you want in rod and main bearings
- Nitro Black dry film lubricant coating increases lubricity, reduces friction, and increases load capacity
- Tri-metal material
- Oversized chamfers for large radius fillets
- High crush and no flash plating to improve seating
- Medium eccentricity to maintain uniform oil clearance

Contact: 303-424-3200
enginepro.com



ENGINEQUEST LLC LS HEAD STUD KITS

- Made of SCM 435 chromoly
- Dacromet silver coating protects against rust
- Evaluated for load, sheer and stress, as well as material identification at a third-party, US-based laboratory to ensure quality
- Kit includes studs, washers, 12-point nuts, and torque lube
- Two versions available: HS349NE for 2003 and earlier model, HS349NL for 2004 and later model

Contact: 800-426-8771
enginequest.com



ETL PERFORMANCE PRODUCTS INC. ETL PERFORMANCE 2013- 2017 DODGE RAM CUMMINS 6.7L INTERCOOLER KIT

- Improves performance over stock intercooler
- All tubing in the kit is manufactured from T304 stainless compared to mild steel
- Direct replacement for stock intercooler
- Bar and plate construction kit comes with everything you need for installation

Contact: 234-575-7226
etlperformanceproducts.com



**HIGH PRECISION LANDIS
CNC GROUND CAMS
MADE IN THE USA**

SCOTT TAYLOR

**STOP BY OUR BOOTH
TO SEE SCOTT TAYLOR'S
ALL-NEW STREET OUTLAWS:
NO PREP KINGS CAMARO**

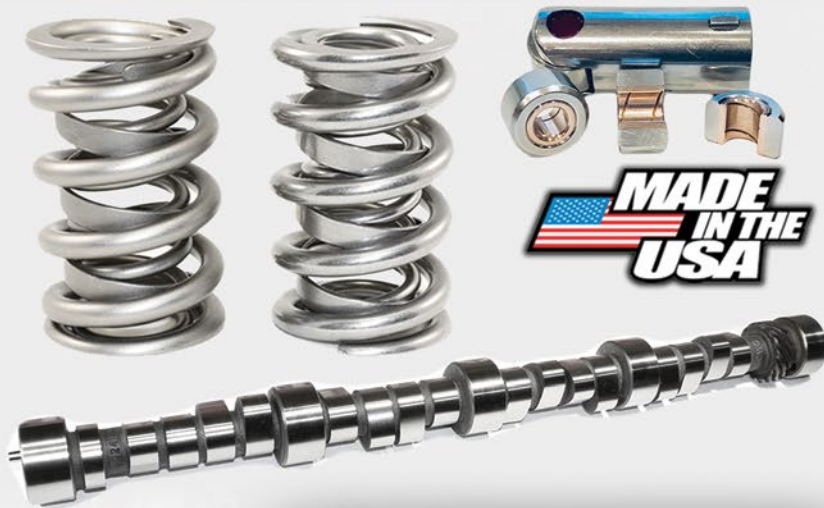

**LEGENDARY INNOVATION
AND WINNING PERFORMANCE
FOR OVER 75 YEARS!**

**DON'T MISS ALEX TAYLOR
IN OUR BOOTH ALL WEEKEND,
STOP BY AND SEE HER
1XX PROOF 55 CHEVY!**



ALEX TAYLOR

DO IT RIGHT... RACE WITH THE LEGEND

**PRI BOOTH #3913
DECEMBER 8-10, 2022**

SHOP ONLINE 24/7 - TRY OUR EASY MAKE AND MODEL SEARCH
WWW.ISKYCAMS.COM
(310) 217-9232  @ISKYRACINGCAMS  /ISKYRACINGCAMS



FASS DIESEL FUEL SYSTEMS COMPETITION SERIES FUEL SYSTEM

- Up to 540-GPH flow rate
- Dual motors for maximum flow and reliability
- -10 O-ring inlet and outlet
- Engineered specifically for diesel motorsports

Contact: 636-433-5410
fassride.com



FITECH EFI GO SPARK ADVANCED CDI

- Multi-spark output
- Optimized for EFI or carburetors
- LED display for programming parameters
- Onboard push-button adjustments
- Programmable (3) rev limits, start retard, and nitrous retard
- Fault code detection

Contact: 951-340-2624
fitechefi.com



FLEECE PERFORMANCE ENGINEERING FREEDOM

SERIES 6.6L DURAMAX CYLINDER HEAD WITH CUPLESS INJECTOR BORE FOR LB7

- All-new Freedom Series cylinder heads for the LB7 6.6L Duramax now with a cupless injector bore
- Save time and money with no more injector cups to install, leak, or worry about
- Cupless injector bore, new aluminum casting, new valves, valve guides, new springs, and new valve seals
- CNC cut, multi-angle valve job

Contact: 317-286-3573
fleeceperformance.com



FLUIDAMPR FLUIDAMPR LT4 PERFORMANCE DAMPER

- Premium viscous crankshaft damper for the 6.2L LT4 supercharged engine
- Fits 2017-2022 Camaro ZL1 and 2016-2019 CTS-V
- Precision-machined high-grade steel components
- Corrosion-resistant black zinc chromate finish
- SFI 18.1 Credentials
- Made in the USA

Contact: 716-592-1000
fluidampr.com



FLUIDYNE HIGH PERFORMANCE LATE MODEL DIRT OIL COOLER

- Top performer in the dirt late model series
- Works well in most oil cooler applications
- Dual flanges for easy mounting
- 12AN inlet/outlet with 1/2-inch NPT fitting for pressure/temperature sensor
- Hand built and completely TIG-welded

Contact: 888-358-4396
fluidyne.com



FRAGOLA PERFORMANCE SYSTEMS FRAGOLA EFI FEED LINE KITS

- Fragola's new EFI feed line kits come premade to the correct length
- Includes gauge port adapter
- Fits popular Holley EFI Sniper kits including Super Sniper, Stealth 4500, and Q-Jet models

Contact: 866-337-2739
fragolaperformancesystems.com

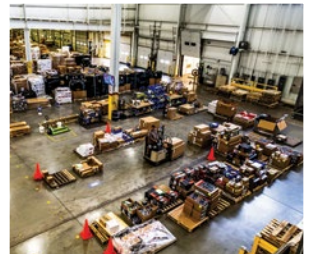

BUILDING TRUST. FUELING PASSION.

Our state-of-the-art facility performs at the highest level to serve our dealers with trust and passion. From the east to the west coast, and worldwide, Motor State proudly serves several markets including Drag Racing, Engine Builder, Circle Track, Open Wheel, Modern Muscle, Hot Rod, Early Muscle, Jeep, Truck, and Off-Road.

Become a Motor State Dealer. Visit our website and apply today.

WWW.MOTORSTATE.COM

800.772.2678



YouTube



FUNK MOTORSPORT LTD. MK3 TURBO BLANKET BY FUNK MOTORSPORT

- The new standard in turbo blankets, featuring unrivalled durability and performance from our signature four-layer construction
- Available for all vehicles, in three different finishes: titanium, carbon fiber, and "Inside Out"
- "Inside Out" finish is new for 2022, for applications requiring heat protection on the outside as well as the inside

Contact: +44 0207 458 4172
funkmotorsport.com



GET'M PERFORMANCE PRODUCTS LLC CUSTOM FOUR-BARREL CARBURETOR FUEL SYSTEM

- GET'M Performance all-billet carburetor, unique two-piece billet fuel bowls, ultra-efficient billet metering blocks, and our Phillips-headed precision jets and air bleeds
- GET'M Performance fuel log, featuring Fragola brand fittings
- GET'M Performance bypass regulator
- GET'M Performance liquid-filled pressure gauge
- Superior customer support
- Made-in-the-USA quality

Contact: 270-935-5334
getmperformance.com



GREEN FILTER USA GREEN FILTER SPRINT CAR FILTER ASSEMBLY PART NUMBER 4069

- Washable and reusable
- Customizable mounting
- Traps particulates as small as 5 microns
- Increased airflow creates more potent air/fuel mixture
- Increased horsepower
- Improved throttle response
- Greater torque throughout your engine rpm range

Contact: 724-430-2050
greenfilterusa.com



H&H SPECIALTIES HARD BLOK

- Hard Blok premier water jacket filler
- Designed for more horsepower
- Stiffens cylinder walls
- Reduce blow-by and compression loss
- Extends engine life
- Dampens harmonic vibrations
- Adds bottom-end rigidity

Contact: 865-457-0509
hardblok.com



HALTECH ENGINE MANAGEMENT SYSTEMS PD16 PDM + FLYING LEAD HARNESS (5M)

- New 16-channel PDM
- 10 x high side outputs
- 2 x half bridge outputs
- 4 x 25A high current outputs
- 8 x inputs + dedicated ignition switch input
- Power for ignition switch
- Integrated into Haltech CAN Bus network
- 5V sensor supply/sensor ground
- 120A SurLok connector

Contact: +61-2-9729-0999
haltech.com



HOWARDS CAMS & RACING COMPONENTS PROMAX 2618 FORGED RACE PISTONS

- Forged from 2618-T61 billet aluminum bar stock
- Less than 1% silicon particulate content
- CNC turned skirts
- Radius valve reliefs
- Oversized valve pockets
- Forced pin oilers
- Accumulator grooves for improved ring seal
- Machined oil drain back holes
- Lock removal indents
- Double spirolox
- Lightweight aircraft quality wrist pins included

Contact: 920-420-2540
howardscams.com

CROWER **CUSTOM CRANKS & RODS**

CROWER MANUFACTURES CUSTOM CRANKS, RODS & CAMSHAFT GRINDS FOR YOUR VINTAGE RACE CAR

RODS

- ALL CROWER RODS ARE DESIGNED TO YOUR HP AND RACING APPLICATIONS
ROD DESIGNS FROM 400 HP TO 4,500+HP
- AVAILABLE IN ANY BIG END BORE WIDTH AND PIN DIAMETER
- ALL CROWER MAXI-LIGHT RODS ARE DESIGNED WITH STROKER CLEARANCE

MADE FROM THE FINEST
AIRCRAFT QUALITY
TITANIUM & STEEL BILLET

PROFILED
REAR FLANGE

DRILLED & CHAMFERED
PIN OIL HOLE

ONE PIECE HIGH
ALLOY BUSHING

1/8" JUMBO RADIUS
ENSURES THE BEST
POSSIBLE STRENGTH
IN OUR CRANKSHAFTS

Shop Now



GUN DRILLED FOR A LIGHTER
OVER ALL CRANKSHAFT

AIRCRAFT QUALITY
12 POINT CAP
SCREW FASTENERS



CRANKS

- 4340 AIRCRAFT QUALITY FORGING
- PRECISION GROUND BEARING SURFACES
- NITRIDE TREATED FOR OPTIMUM SURFACE HARDNESS
- STRINGENT TOLERANCES
- CUSTOM BALANCING AVAILABLE
- LIGHTENED FOR REDUCED ROTATION MASS



**PROUDLY
MANUFACTURED
IN THE USA**

Get social with us

www.crower.com | 619.661.6477 |





HPL SUPERIOR LUBRICANTS/AFIS AFIS RACE FUEL INJECTORS

- Designed for low base fuel pressure (43.5 psi)
- All stainless steel internal construction and over-molded coil design
- Linear operation to 90% duty cycle
- Compatible with methanol, ethanol, and race fuel
- Sold in flow-matched sets (250, 400, 600, and 800 lb/hr)
- Limited lifetime warranty

Contact: 219-996-3460
hploil.com



HYLIFT JOHNSON AUTOMOTIVE AND MOTORCYCLE ENGINE LIFTERS

- Hydraulic flat and roller lifters
- Mechanical flat and roller lifters
- Retrofit tie bar lifters
- Direct shot oiling
- OEM and Type II material
- Lightweight design
- High-performance options available
- Made in the USA

Contact: 773-487-1400
toplineauto.com



HYPERCRAFT HYPERPACK BY HYPERCRAFT

- HyperPack is a modular battery system capable of low and high voltages up to 800V
- These 10 kWh packs connect in series for 20–120 kWh of capacity
- Plug-and-play high/low voltage connectors, high-voltage switching, high-voltage interlock, and battery management are integrated into the IP65 aluminum enclosure

Contact: 720-271-7340
hypercraftusa.com



HYPERMAX ENGINEERING PULSE TURBOCHARGER

- Hypermax Engineering released its first product, the Pulse Turbo kit, in 1983 for vehicles with the International 6.9/7.3 IDI engine
- In 1988, a kit for the 7.3 IDI was released
- A 50% increase in horsepower and 1–3 mpg improvement in fuel economy makes this kit a great addition to your Ford pickup or van as well as International S-Series trucks

Contact: 847-428-5655
gohypermax.com



IGNITIONEERING/B.R. MOTORSPORTS BR BLACK MAGIC MAGNETOS

- Used by top teams around the world
- Precisely blueprinted to produce maximum amperage output
- Available applications include 44 amp, 20 amp, and 12 amp magnetos
- BR Motorsports can also convert your existing magneto to the Black Magic series

Contact: 559-739-1515
brmotorsports.com

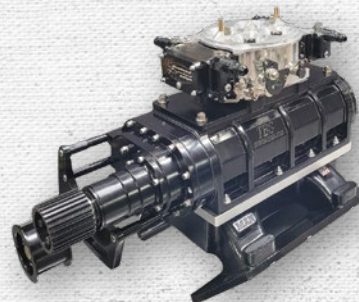

INDY CYLINDER HEAD INC. 250 BLOWER PLATE

- We have made a new supercharger top plate for the 250 blower that fits all of our Mod-Man intakes
- We have Mod-Man intakes for small block Mopar, LA, Magnum, and W-2
- We also have 400B or 440RB standard port or Max Wedge, 426 Hemi 16 bolt, 5.7 and 6.1 Hemi
- We also have AMC available

Contact: 937-708-8563
indyheads.com

JOIN THE RANKS OF CHAMPIONS



Join the ranks of champions in NASCAR, IMSA, World Of Outlaws, SCORE Off-road, circle track, and drag strip. Precision engineered to outperform the competition and a racer's best value, most PowerPak piston sets are sold complete with performance rings, pins and clips and are dual coated.

New piston sets introduced in 2023 include BB Mopar Dish and Flat Top, Ford Powerstroke 6.0L (cast) and Ford 6.4L Powerstroke, Ford Godzilla 7.3L, SBC 22°/23° Flat Top Gasported, SBC 23° USRA approved, SBC 22° ASCS 360 Sprint Dome gas ported, LS 5.3L (Gen III) Flat Top and more. Check out all our new PowerPak sets, rings, pins and rails today at www.mahlemotorsport.com.

1-888-255-1942



follow us on social media
@MAHLEMotorsport_NA

Scan this QR code
to download our
Application Guide



PRI booth# 1601

MAHLE

Motorsport



IS MOTORSPORT AUTOSPORT CONNECTORS

- Stocking all series: AS / ASX / ASL / ASU / ASR / ASC / ASDD / ASHD
- Compact design/minimum space envelope
- Interfacial and wire sealing
- Boot termination feature
- PCB option
- Universal option available
- Standard crimp tooling
- Suitable for blind mating
- Visual indication of keyway orientation of connector
- Scoop-proof interface
- Shell-to-shell grounding

Contact: 317-244-6643
is-motorsport.com



JE PISTONS SRP PROFESSIONAL PISTONS—GM LS

- More than 100 off-the-shelf part numbers designed for various LS engine platforms with piston specifications covering many use applications to meet your power goals from street to strip
- Designed with Multi-Fit valve pockets to accommodate popular 12° and 15° LS heads
- Forged in the USA using 2618 aluminum, yielding high-tensile strength needed for high-demand performance applications

Contact: 714-898-9763
jepistons.com



JESEL INC. JESEL PREMIUM STUD ROCKERS

- 2024 aluminum
- Shot-peened finish
- Dual 3/8-inch wide bearings
- External thrust washers
- Tool steel trunnion
- 3/8-24 cup style adjuster
- Needle rollers
- ARP hardware
- No stud girdles
- No pushrod guide plates

Contact: 732-901-1800
jesel.com



K1 TECHNOLOGIES FORD 351 WINDSOR CRANKSHAFT

- Forged from 4340 forged steel
- Features straight-hole oiling for improved lubrication
- Core hardened, nitride hardened for optimum strength, increased fatigue life, and minimized distortion

Contact: 616-583-9700
k1technologies.com



KATECH ENGINEERING LLC KATECH GEN-V LT WET SUMP OIL PUMP

- Part number KAT-A7502
- Bolt-in replacement oil pump
- 4140 billet steel single gear
- Eliminates factory powdered metal gear
- No tuning required
- Maintains OEM oil pressure
- No core, brand new pump
- Fits LT wet sump engine: LT1, LT4, LT5
- L83/L86 truck version also available, part number KAT-A7503

Contact: 586-791-4120
katechengines.com



KINSLER FUEL INJECTION INC. RACE SAVER 305

- Race-proven RS 305 manifold package
- Precision cast aluminum, better corrosion resistance and light weight
- Includes: Transverse throttle shafts, 100% CNC-machined runners, 180° bell aluminum ram tubes, jack-shaft linkage and billet throttle connection bars, barrel valve with CNC-contoured spool, Super Top ram tube adapter, Kinsler precision nozzles, HP nozzle hoses, and billet valley plate

Contact: 248-362-1145
kinsler.com



YOUR COMPETITIVE ADVANTAGE

TURN14 x
DISTRIBUTION

AEM
PERFORMANCE ELECTRONICS

X-SERIES WIDEBAND UEGO AFR SENSOR CONTROLLER GAUGE

Turn 14 Distribution is the premier B2B source for AEM's high performance racing electronics. As a valued dealer, we provide you with access to industry-leading customer support, real-time inventory, flat rate shipping from our strategically located distribution centers, and 100% hassle-free returns.

100% WHOLESALE | TURN14.COM



KOOKS HEADERS & EXHAUST
**2016-2022 CAMARO SS/
 ZL1 1-7/8-INCH STAINLESS
 HEADERS AND GREEN
 CATTED OEM CONNECTORS**

- 304 stainless steel
- Kooks Greencats
- EPA verified
- Help remove harmful emission from exhaust
- Constructed with low cell count high-flow substrate
- S-shaped designed substrate for added durability

Contact: 704-768-2288
kooksheaders.com



**KPXA - KEN PERRY'S
 XTREME ARIAS
 KPXA RACE ENGINE**

- Utilizing the most advanced five-axis CAM software, KPXA's capabilities are showcased in the latest concepts of this innovative engine
- Advanced design and manufacturing technologies produce stunning finishes while holding the tightest of tolerances
- This is a newly designed Arias platform with many advancements: raised cam, superior oiling, individual rockers

Contact: 905-475-9712
kpxa.ca

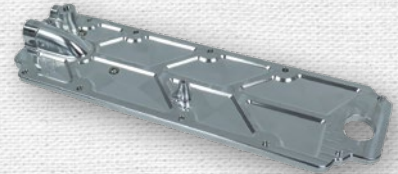

LATE MODEL ENGINES LLC
**GM LT1/4/5 BILLET BAFFLED
 VALLEY COVER**

- Baffled
- -12AN breather
- Factory oil port thread (M12-1.75)
- All factory mounting locations for fuel lines and lifter
- AFM delete block-offs—fits with plugs already installed in the block
- Utilizes factory gasket (included)
- Fits all LT blocks including L8T

Contact: 713-849-4505
latemodelengines.com



LOS ANGELES SLEEVE CO. INC.
**4B11T MITSUBISHI EVO-X
 PERFORMANCE SLEEVE KIT**

- Made from our MOLY200 performance iron
- Allows standard bore to 90 mm
- Better cooling with ProCross ProCool design
- Capable of up to 1,500 hp

Contact: 562-945-7578
lasleeve.com



M & M COMPETITION ENGINES
1 SPEC EVOLUTION BLOCK

- Cast iron SBC block
- STD or LT1 reverse cooling
- Deck heights 9.025-9.325 inches
- .391-inch raised CAM
- 4.400-4.500-inch bore center
- Wide oil pan rail
- Oil filter provision
- 55-mm roller or 60-mm babbitt
- 350 or 400 main
- One- or two-piece rear main seal
- 9.5-9.8-inch +1.053-inch CAM versions coming soon

Contact: 317-739-3187
mmcompetitionengines.com

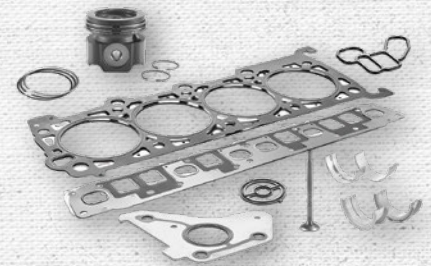

MAHLE AFTERMARKET INC.
**ENGINE GASKETS, BEARINGS,
 AND PISTON RINGS**

- The finest parts for the most astute engine builders around
- High-performance engine bearings, piston rings, and gaskets that are designed for demanding performance applications

Contact: 248-347-9700
mahle-aftermarket.com

JONES

Racing Products.com



72 Annawanda Road • Ottsville, PA 18942-9702 • (610) 847-2028 (610) 847-8895

DIRT LATE MODEL

Dual-dowel front design allows pulleys to be added for race or dyno



Large billet crankshaft nut. Independent balancer bolt for strength & weight savings



Proper Belt Size Provided no tensioner is required increasing efficiency & reliability

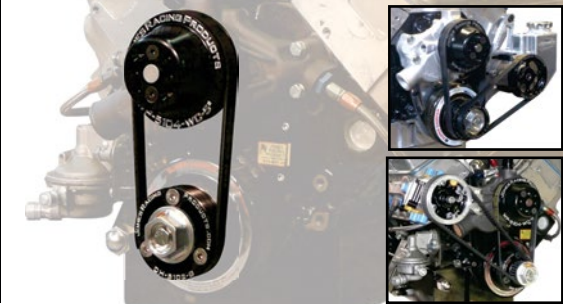

PS-9008-AL-AR

Lightweight Alum. PS Pump with Built-In High-Capacity Alum. Tank



Low Drag Asphalt

Positive-Engagement Radius Tooth Belt Drive w. Billet Aluminum Pulleys



High Capacity Fabricated Aluminum Power Steering Reservoir



Mini One-Wire Alternator 75 Amp High-Output 6 Lb. Lightweight Design

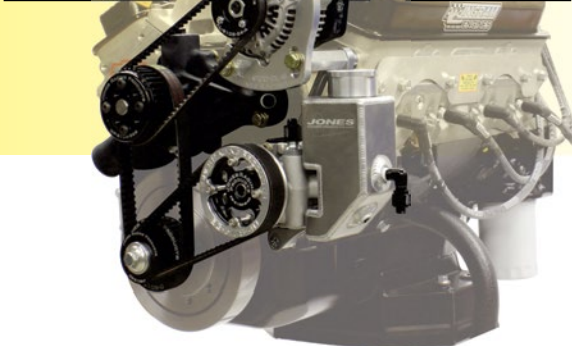

602/604 CRATE

SBC Circle Track Complete Front Drive

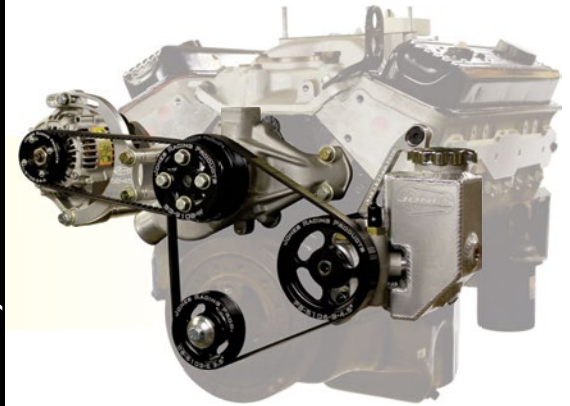

DIRTcar

Positive-Engagement Radius Tooth Belt Drive w. Billet Aluminum Pulleys



1/2" Thick Billet Alum. Bracket Supplied with Proper Length Billet Spacers & Hardware



Mini One-Wire Alternator 75 Amp High-Output 6 Lb. Lightweight Design

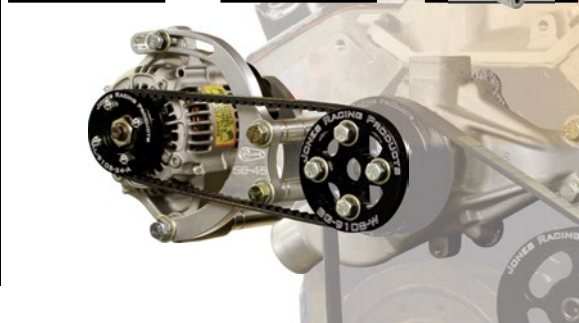

WP-9104-17-H3

Lightweight 3-Blade Fan



WP-9104-17-H3
Also available in:
14, 15, 16, 17, 18 & 19"



HUSTLER 3-Blade Fan



MANLEY PERFORMANCE PRODUCTS INC.
640000CPE-10

- Audi R8 and Lamborghini V10 5.2L FSI
- Special skirt coating for use in factory blocks with Nikasil-coated cylinders
- For 84.5-mm bore and provides 10.0:1 compression
- They are supplied with .210-inch wall 9310 material pins and premium steel top ring sets

Contact: 732-905-3366
manleyperformance.com

MARADYNE HIGH PERFORMANCE FANS
JETSTREME PLATINUM SUPREME



- Shrouded fans
- Low profile
- Works as a puller
- Proprietary sickle-blade design
- Low noise
- High air movement (1700 CFM – single; 3400 CFM – dual)
- Extreme engine cooling capability
- Minimal AMP draw (15 amps – single; 29 amps – dual)
- Durable glass filled nylon construction
- IP68 rated
- Designed, tested, and manufactured in-house

Contact: 216-404-7168
maradynehp.com



MASTA PERFORMANCE INC.
CUSTOM TRANSMISSION DIPSTICK & TUBE ASSEMBLY

- A custom transmission dipstick and tube assembly for 4L8E trans to LS motor

Contact: 248-685-8710
mastaperformance.com

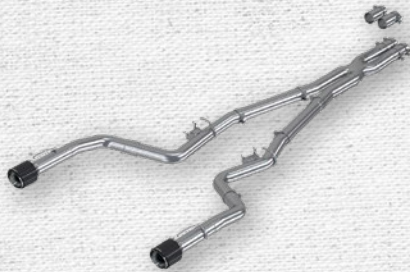

MBRP LTD.
2015+ DODGE CHARGER, 3-INCH CAT-BACK, RACE PROFILE EXHAUST

- 2015+ Dodge Charger, 5.7L, 6.2L, 6.4L engines
- 3-inch cat-back
- Dual rear exit, carbon fiber tips
- Race sound profile
- Armor Pro, T304 stainless steel
- Lifetime warranty

Contact: 888-636-7223
mbrp.com



OPTITORQUE TECHNOLOGIES
7.3 GODZILLA V8 TORQUEMASTER HEAD STUD KIT

- Manufactured from domestic 230 ksi HSLA steel
- Metric J-13mm thread profiles on both ends
- Precision centerless ground
- Extended high fatigue stretch region
- Heavy wall m13 forged - 12 point nuts
- Thru-hardened ground washers
- Engineered from factory blueprints

Contact: 315-924-3888
optitorque.com



P1 MANUFACTURING
HEAD STUD KIT FOR SMALL BLOCK CHEVROLET, KIT #K016

- 8740 chromoly steel improves wear resistance and strength
- 190,000 psi tensile strength
- Black oxide finish prevents corrosion and increases longevity
- In-house engineering and finishing processes, such as cold heading, hot heading, vacuum heat-treat, CNC grinding and thread forming
- Designed for small block Chevrolets
- Made in America

Contact: 417-753-5174
p1mfg.com

DARTON SLEEVES™



**Great Product
Great Service**

Quick Turnaround on
Customs

We Always!!! Answer the
Phones When Called

Win With The Best in all
Categories Of Product,
Support & Quality

DARTONSLEEVES.COM

WEST: (800) 713-2786 or (760) 603-9895

EMAIL: sales@dartonsleeves.com

PAC RACING SPRINGS PAC-1237X AND PAC-1238X / RPM SERIES DUAL VALVE SPRING

- Over 30% weight savings compared to 1.550-inch springs
- Designed for street/strip
- Mini 8° retainers for 3/8-inch to 7-mm stems
- Manufactured with PACaloy
- In-house heat-treat polishing
- PAC patented Nano-Peen
- PAC-1238X up to 0.750-inch lift 250 lbs. at 1.800-inch 600-lb. rate

Contact: 866-799-9417
racingsprings.com



PBM PERFORMANCE PRODUCTS ERSON STAINLESS VALVES

- Manufactured from premium forged alloys to exacting tolerances
- Incorporates features like a precision-machined face for consistent volume, precision-ground keeper grooves to eliminate stress risers, and an undercut stem Powerflow design to ensure dependable, long-lasting performance
- Designed for compatibility with most popular engine applications with styles for street performance to professional level racing

Contact: 502-937-6946
pbm-erson.com



PERTRONIX INC. IGNITION POWER PACKAGE

- Includes the Digital HP Capacitive Discharge Ignition Box and the Flame Thrower III Coil
- Provides more power, faster starts, higher rpm range, and quicker acceleration

Contact: 909-599-5955
pertronix.com



PETERSON FLUID SYSTEMS INC. PETERSON FLUID SYSTEMS REMOTE FILTER BYPASS

- Prime the engine quickly without removal of components using a standard hand drill
- Multitude of sizes and styles for any application
- Tube, tank, and panel mounting
- Optional screw-on-filter bypass allows for additional filtration options
- 6061 T6
- Black anodized

Contact: 303-287-1731
petersonfluidsys.com



PIPER CAMS FORD ECOBOOST CAMSHAFTS

- Ford EcoBoost 1.6, 2.0, and 2.3 engines
- Mild road to full race profiles
- Ground in-house, using state-of-the-art CNC cam grinders
- Profiles designed in-house
- Valve spring kit also available

Contact: +44 0 1303 245300
pipercams.co.uk



PMAS TECHNOLOGIES LLC M.I.D. MODULAR INLET SYSTEM

- Designed to decrease restriction and increase airflow into inlet ducts or turbo/supercharger applications
- Uses a large bellmouth base with easily swappable race screens, high-flow wire only race filters or normal filter systems in many different sizes

Contact: 517-983-8537
pmas-maf.com

True Beauty is
on the Inside



ENERGY



VISIT US AT PRI BOOTH 4709   

CALLIES PERFORMANCE PRODUCTS * WWW.CALLIES.COM * 419-435-2711



POWERMASTER PERFORMANCE HPR ALTERNATORS FOR 12-, 14-, OR 16-VOLT ELECTRICAL SYSTEMS

- High output HPR alternator specifically for 12-, 14-, and 16-volt electrical systems
- Two models available: 145/175 and 195/245 amp (idle/top end)
- One-wire installation and 3-inch solid pulley
- Direct bolt-in for LS engines and most late model Ford and Mopar CCW rotation
- Also available for reverse mount applications
- Made in the USA

Contact: 630-957-4019

powermasterperformance.com



PROCHARGER SUPERCHARGER SYSTEMS F-4X-140-1 RACE SUPERCHARGER

- Capable of 3,700+ hp
- Highest durability for race applications
- Employs the fully redesigned F-4X gear case, a complete redesign that maximizes power capabilities and product durability, a massive collaborative effort with engine builders and racers
- Suitable for several race classes, including NMCA Xtreme Pro Mod, PDRA Pro Boost, and Pro275

Contact: 913-338-2886

procharger.com

PROGRESSION IGNITION LLC SMART IGNITION DISTRIBUTOR WITH BLUETOOTH



- Smart Ignition Distributor for the most popular classic engines from Chevy, Ford, Chrysler, etc.
- Tune ignition timing with smartphone or tablet, iOS and Android
- Tunable 12x12 timing table
- Real-time gauges screen
- Automatic start retard
- Main rev limiter
- Launch rev limiter with Launch Retard Control
- Nitrous retard
- Data logging
- Boost ready

Contact: 714-332-9990

progressionignition.com



PRW INDUSTRIES INC. PRW LS SUPERCHARGER GIRDLE PULLEY KIT 2636413

- PRW has the answer to strengthen your LS water pump pulley for supercharged LS engines
- Our Pulley Girdle Kit will bolt on to aftermarket eight-bolt hubs to brace your pulley for supercharged applications
- Made of 6061 billet aluminum and includes a polished aluminum pulley, girdle, fasteners, and thread locker
- Part number 2636413

Contact: 951-436-7900

prw-usa.com



QUALCAST BLACK LIGHTNING DIESEL PERFORMANCE VALVE KITS

- Performance valve kits for Cummins/Dodge, Ford Powerstroke, and GM Duramax diesel engines
- Includes Black Lightning race valves, keepers, performance springs, retainers, and stem seals
- Each kit has components quantities for one engine whether it is a 12-, 24-, or 32-valve engine
- Designed for heat endurance with extra spring pressure

Contact: 615-777-3863

qualcast.com



RACETEC PISTONS CHEVY LT1/LT4 SHELF PISTONS

- 100% USA-made pistons
- Diamond tooling used for tight tolerance
- For boosted and NA applications

Contact: 714-903-4362

racetecpistons.com

FUELING YOUR
PASSION

VB40aX1 & X2

VOLTAGE BOOSTER

SINGLE & DUAL PUMP

BOOST THE POWER, BOOST THE PERFORMANCE

Get More from Your Existing Fuel Pump

- Most advanced pump voltage booster on the market
- Compatible with in-tank, in-line, brushed, and brushless fuel pumps
- Dedicated brushless mode maximizes brushless pump performance
- Intuitive programming via roller wheel and OLED screen
- User defined pass code protection



*26v on brushless pumps



- Single and dual pump models (X1 and X2)
- Brushed mode up to 20v and Brushless mode up to 26v
- Adjustable ramp rate to avoid fuel pressure spike
- 6160 T6 aluminum case with integrated finned heat sinks
- Compatible with DW brushless controllers
- Endurance tested to 40amps RMS

VB40aX1 Single Pump Voltage Booster: \$399

VB40aX2 Dual Pump Voltage Booster: \$449

WWW.DEATSCHWERKS.COM
405.217.0701 / 800.419.6023





RED LINE SYNTHETIC OIL SUPERCOOL PERFORMANCE

- 50/50 prediluted—ready to use
- Reduces coolant temps by up to 20 degrees Fahrenheit
- Works with all makes and models
- Mixes with any coolant color
- Gas and diesel engines
- Cast iron, aluminum, and brass systems
- Warranty compliant

Contact: 707-745-6100
redlineoil.com



RUSEFI LLC RUSEFI PROTEUS

- A GPL open-source EMS
- Universal units for 4-, 8-, and 12-cylinder applications
- Dual CAN bus, dual DBW, knock detection
- Custom strategies and CAN integration via Lua Scripting

Contact: 773-414-1279
rusefi.com



S&S DIESEL MOTORSPORT LLC LB7 DURAMAX SAC00 FUEL INJECTORS

- Modern SAC-style nozzle in favor of the outdated VCO-style
- Increased fuel injector lifespan
- Co-developed by S&S Diesel Motorsport and Bosch
- CARB compliant (EO number D-756-2)
- Stock fuel delivery, no calibration required
- Each set is tightly balanced and includes a report
- Direct replacement for 2001–2004 GM Duramax-powered pickup trucks

Contact: 812-521-0123
ssdiesel.com



SBI VALVETRAIN PRODUCTS PERFORMANCE DIESEL VALVE SPRINGS

- SBI Valvetrain Components Performance Diesel Valve Springs for Cummins, Ford Power Stroke, GM Duramax
- Improved open and closed pressures
- Gas nitride finish
- Surface hardness increases fatigue life of spring by 32%
- Creep resistance of spring increases by 45%

Contact: 615-248-6281
sbintl.com

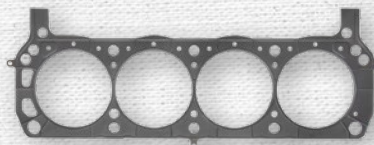

SCE GASKETS INC. MLS SPARTAN HEAD GASKET

- Multi-layer stainless steel with Gas-Stopper
- High-grade, shape-memory AISI 301 stainless steel
- Embossments with uniform molecular grain structure in the radii increase spring-contact with the block and head while reducing stress points
- Gas-Stopper concentrates clamp load at critical sealing areas around combustion chambers

Contact: 800-427-5380
scegaskets.com



SCHUMANN'S SALES & SERVICE SBC OIL PUMP AND GEARS

- 12 patents issued, pending, and applied for
- Energy recovery
- Paddle wheel
- 140 ball valve
- Dimple tech
- Anti-cavitation
- PI intake port
- O-ring sealing
- FPS feet per second

Contact: 563-381-2416
schumannssalesandservice.com

SHOP TEAM-TRUSTED STORAGE ONLINE!



- *Configure Custom Cabinets*
- *Explore Pit Carts & Accessories*
- *Get Race Day Ready*



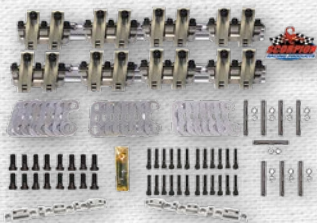

SCORPION RACING PRODUCTS SHAFT MOUNT ROCKER ARMS

- 100% made in the USA
- 7000 series aerospace grade aluminum bodies
- 0.562-inch diameter centerless ground shafts
- All steel components manufactured from ASTM-certified bearing quality steel
- Available for SBC and SBF applications with more applications coming soon
- Direct pressure-fed oiling, valve spring oiling, and bushing upgrades available

Contact: 352-512-0800
scorpionracingproducts.com



SCOTT PERFORMANCE WIRE HIGH PERFORMANCE IGNITION WIRES

- Proprietary 30 GOLD conductor core
- Low ohms/high inductance
- Exceptional EMI/RFI noise suppression
- Stock and custom lengths
- Multiple color and sleeving options
- Precision manufactured
- Individually tested
- Sourced and produced in the USA

Contact: 704-664-9700
sparkplugwires.com



SHAFTECH LTD. DIAMOND CLAW

- Diamond Claw friction washers eliminate loose bolts and this type of damage
- At .012-inch thickness, they will not change assembly spacing and can be reinstalled multiple times
- Diamond Claw friction washers are ideal for crankshaft flanges and damper fits
- Effective with steel/titanium/aluminum
- Custom applications available
- Short turnaround for prototyping

Contact: 419-423-1000
shaftech.com



SHURIKEN BY METRA ELECTRONICS SHURIKEN LITHIUM BATTERIES

- Compact and lightweight
- Quick energy discharge
- Internal components sectioned into independent cells for safer batteries less likely to short out if damaged
- Long-lasting, reliable, and vibration-resistant
- Recharge quickly and hold a charge longer than conventional batteries
- Applications for auxiliary power, RVs, racing, powersports, and more

Contact: 386-257-2956
metraonline.com



SPA PERFORMANCE K20 HONDA CIVIC 8TH GEN CAST ALUMINUM INTAKE MANIFOLD

- Designed for high-performance builds, especially forced induction ones, due to its strong cast aluminum construction
- It has a big plenum and runners designed for high airflow applications
- Available for four or eight injectors
- Includes fuel rail
- Supports up to 95-mm throttle body without any major modifications

Contact: 980-444-0650
spaturbousa.com



SPAL USA SPAL 30107328 HIGH- PERFORMANCE SEALED AND BRUSHLESS ELECTRIC COOLING FAN

- 16-inch flush mount fan features a 500W brushless motor
- Utilizes same mounting footprint as SPAL 16-inch, VA18, and VA33 brushed fans 2,433 CFM (free-air) rating
- Works with SPAL plus sensors

Contact: 630-336-5614
spalusa.com

SHOP TESTED FIELD PROVEN

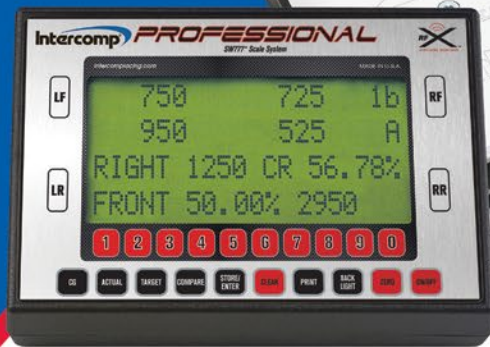

SW777RFX™ PROFESSIONAL Wireless Scale System

RFX® WIRELESS SCALES

Intercomp's Wireless Scale Systems combine our **ultra-accurate 6061-T6 Billet Aluminum Scale Pads** with Intercomp's tested & field proven advanced RFX® Wireless Weighing Technology. **Bluetooth® Technology** is included with all RFX® Wireless Scale Systems and securely displays live weight data from the indicator to the user's Bluetooth®-enabled mobile device with the Intercomp iRaceWeigh™ app installed.

intercompracing.com

+1 763-476-2531 Worldwide



Intercomp®
advanced weighing technology... by any measure



SPINTRAC PRO CNC MACHINED DRY SUMP OIL TANKS

- Spintrac Technologies manufactures a complete line of pro-racing CNC machined dry sump oil tanks, atmospheric vent cans, centripetal air/oil separators, mini dry sump oil pumps, and more

Contact: 916-652-5282
drysump.com



SYSTEM 1 FILTRATION PRODUCTS NEW TALL SYSTEM 1 FILTERS

- New 7-inch Tall System 1 cleanable and reusable filter
- Multiple threaded mounting options available
- Easy inspectable filtration you can count on
- Flows up to 40+ gallons per minute
- Available for fuel and oil applications

Contact: 559-687-1955
system1filters.com

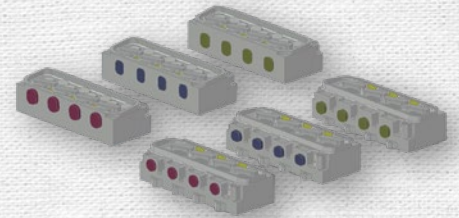

TITUS PERFORMANCE TITUS ALUMINUM CLEVELAND CYLINDER HEADS

- Aluminum 351 Cleveland-style cylinder heads
- Port heights available in three sizes: standard Cleveland height, 3.9 inch, and 4.3 inch
- CFM ranges from 360 cfm to 450 cfm
- 10 head bolts and/or 14 head bolts for power adders
- Suits the gamut: anything from replacement street heads to extreme-competition combinations

Contact: 301-932-9292
titusperformanceproducts.com



TMG PERFORMANCE PRODUCTS LLC/CORSA PERFORMANCE PRO SERIES TUNED MUFFLERS

- Designed to bring Corsa's signature "hollow" exhaust note to custom builds from all eras
- Reversible straight-through design engineered to eliminate most V8 drone frequencies
- Available in 2.5-inch and 3.0-inch muffler configurations
- Pair with Pro Series packed resonators to reduce overall volume and deepen tone

Contact: 440-891-0999
corsaperformance.com



TOP STREET PERFORMANCE LT GEN V RETROFIT OIL PAN WITH FRAME CUT OUTS

- Low-profile, retrofit oil pan for LT engine swaps
- Composed of lightweight cast aluminum
- Designed to allow for increased clearance to the ground and chassis
- Will fit many GM rear-wheel-drive applications originally equipped with a small or big block Chevy engine and factory rear sump pan
- Mounts perfectly to an LT engine and takes the stock oil filter

Contact: 562-926-5858
topstreetperformance.com

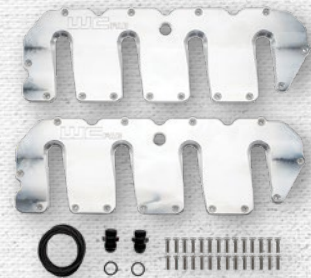

WEHRLI CUSTOM FABRICATION 2004.5-10 DURAMAX BILLET UPPER VALVE COVERS

- Left and right upper valve covers
- CNC-machined billet aluminum
- Flush head stainless hardware
- Black anodized #10 JIC PCV fittings
- O-ring seal
- Raw finish standard, optional custom color powder coat finishes available
- Made in USA

Contact: 630-277-8239
wcfab.com



UNLOCK YOUR VEHICLE'S **MAXIMUM** POTENTIAL!!!

Put the right tools in your toolbox! **FlashScan V3** from EFILive allows you to scan, data log and reprogram your vehicle for maximum performance and outstanding drivability.

FLASHSCAN V3 SPECIFICATION:

- ✓ Fully integrated Scan and Tune Tool.
- ✓ All new V8 tune file editor.
- ✓ Integrate your custom calibrations into the V8 editor.
- ✓ Light duty (CAN J1979, VPW J1850) and Heavy duty (CAN J1939) protocols.
- ✓ Supports 600 VIN Licenses.
- ✓ Large, easy to read color screen.
- ✓ Built in 512MB micro SD Card.
- ✓ Built-in audible alarms.
- ✓ Upgradable firmware.
- ✓ Vehicle input voltage - Min 9V, Max 28V.
- ✓ Battery backed real-time clock.
- ✓ Appears as a Windows USB drive.
- ✓ Built-in power supply prevents data corruption if external power supply is interrupted.
- ✓ Customize menus, colors and images.
- ✓ Read & clear DTC codes.
- ✓ High speed data logging.
- ✓ Display data while logging.
- ✓ Read & program calibration & operating system data of engine controller.
- ✓ Integrates with AutoCal V3 to deliver your own custom handheld tuning device.
- ✓ Automatic saving of trace files.

FLASHSCAN & AUTOCAL V3 COMPATIBILITY:

FlashScan V3 and **AutoCal V3** can be used with the following controllers:

- » Most 2006-2020 Dodge Cummins 5.9L & 6.7L
- » Most 1998-2019 GM Gas Vehicles
- » 2001-2016 Duramax 6.6L
- » 2014-2020 Duramax 2.8L
- » Most 2007-2020 Cummins HD Controllers

FlashScan V3 with one Tuning option US\$1025.00

AutoCal V3 as low as US\$290.00*

*Quantity discounts available

www.efilive.com



THANK YOU 2022 ROAD TOUR SPONSORS

With the support of these great sponsors, the 2022 PRI Road Tour was able to trek across America to various businesses and races.

Want to check out their stories? Go to performanceracing.com/roadtour



SECTION 1

ENGINE COMPONENTS



WELDON PUMP 16000 HIGH VOLUME CARB SERIES PUMPS

- Three versions available: 120 GPH, 250 GPH, and 420 GPH pumps support 600 to 3,000+ horsepower
- Convenient "drop-in" replacement design
- Ultra-efficient brush-type electric motor
- 1.75 square inch Teflon diaphragm
- Tool-steel pump element
- Compatible with all fuels
- -12 ORB inlet/outlet ports
- -8 ORB return-to-tank
- Self-priming

Contact: 440-232-2282
weldonracing.com



WISECO PISTON CO. INC. WISECO PRO TRU CHEVROLET 5.3L FLAT TOP PISTON KIT

- Pro Tru forged piston series features high-quality racing pistons offered at a friendly price point
- Perfect for the street enthusiast and racer on a budget
- ArmorGlide skirt coating
- Premium rings included

Contact: 440-951-6600
wiseco.com

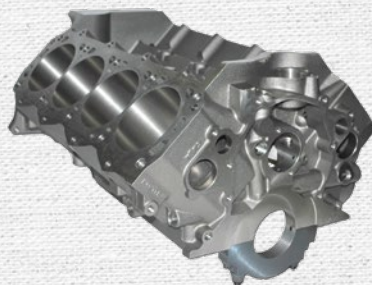

WORLD PRODUCTS MAN O'WAR ENGINE BLOCKS

- Designed to withstand power adder applications
- Cast with schedule 40 iron alloy
- Added thickness to the main webs
- Accommodates any standard SBF cylinder heads
- Six head bolts per cylinder capability
- 100% American made

Contact: 888-317-3501
worldproducts.net



XCENTRICK INNOVATIONS LTD. GEN III RACE TECH SUPERCHARGED/HYBRID FUEL INJECTION SYSTEM

- A supercharged slingshot effect is generated within the intake port, injecting liquid fuel into a precision designed supercharger slingshot apparatus known as a DYNO-BLADE
- Generates a superior fuel injection outcome along with independently verified value-added performance and efficiency
- Known as Supercharged (Hybrid) Fuel Injection or SFI

Contact: 330-373-8106
xcentrickinn.com



OPTIMUM
IGNITABILITY
MAXIMUM
PERFORMANCE



Autolite
IGNITING YOUR PASSION™

Today's engines need advanced ignition for ultimate performance. Autolite® spark plugs are engineered to deliver optimum ignitability, durability and acceleration for every passion – on and off-road.

Ignite your passion at autolite.com



SECTION

2

CHASSIS, DRIVELINE & SUSPENSION

The latest components—including roll cages, rearends, torque converters, differentials, clutch kits, shocks and springs, transaxles, tires and wheels, and more—for race car fabrication and parts sales are included here, as a number of the industry's leading suppliers and service providers have developed products using the latest technology and processes to generate better grip, improved handling, and faster ETs and lap times.

CALVERT RACING, INC.

calvertracing.com | 661-728-9600



CALTRACS

- Patented traction bar system, axle above springs
- Hooks your vehicle, especially on hard acceleration
- Improves 60-ft. times, consistency
- Keeps axle from rotating
- Maintains pinion angle
- Available in low profile, racing configurations
- Complete bolt-on kit (most applications)
- Available for virtually any leaf spring vehicle



CALTRACS FOR TRUCKS

- Patented traction bar system, axle below springs
- Hooks your truck, especially on hard acceleration
- Works on the street, track, or dirt
- Keeps axle from rotating
- Maintains pinion angle
- Available in low profile, racing, Monster configuration
- Complete bolt-on kit (most applications)
- Available for virtually any leaf spring vehicle



CALVERT SPLIT MONO LEAF SPRINGS

- Direct replacement, most applications
- Lighter than most stock springs
- Stress-relieved and arch verified
- Parabolic design distributes stress along length
- Ride height options available
- Heavy-duty alignment clamps
- Aluminum bushings pressed in front spring eyes
- Polyurethane bushings in rear spring eyes
- Available for virtually any leaf spring vehicle



CALVERT SPRING SLIDERS

- Replacement for factory spring shackles
- Heavy-duty roller bearings, decreases friction
- Keeps spring and body from binding during suspension movement
- Available to fit Calvert springs, GM factory springs, and Chevrolet S10 factory springs
- Sold as a pair

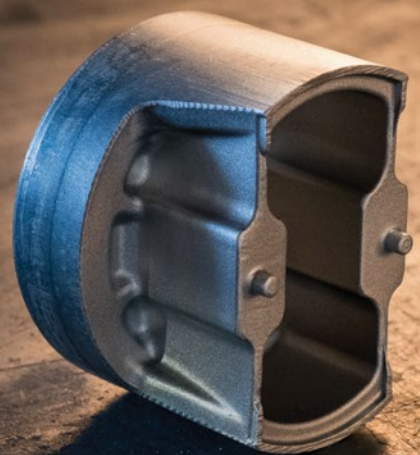
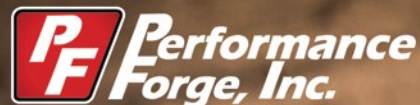

FORGED PISTONS

MADE WITH PRIDE IN THE USA

PERFORMANCE-FORGE.COM

323.722.3460

BLP RACING
PRODUCTS,
LLC.



BILLET
XTREME
BUILDER
COMPONENTS

USA MADE QUALITY

- ✓ BX4 Billet 4150
- ✓ BX4 Xtreme Large bore 4150
- ✓ BX4S 4500 Series
- ✓ BX Series Large bore 4500
- ✓ BXX Spread Bore

BLP offers a wide array of billet made in USA components for the carburetor builder or performance enthusiast. From Main bodies, Base plates, Metering Blocks, Spacers, to complete builds. Along with timing covers, pulley systems. The Original Billet Xtreme!



BX4 XTREME LARGE BORE 4150

BX4 4150 APPLICATIONS

407 422 0394

WWW.BLP.COM

2215 West Church St
Orlando FL 32805
sales@blp.com

PRI MEMBER BENEFITS

DISCOUNTS!

ON



AND OTHER GREAT BRANDS

JOIN TODAY!

VISIT:
PERFORMANCERACING.COM/MEMBERSHIP

PRI MEMBER BENEFITS

10%

DISCOUNT ON ALL
PRI MERCHANDISE

*VALID ON WEBSITE ONLY



JOIN TODAY!

VISIT:
PERFORMANCERACING.COM/MEMBERSHIP

FTI PERFORMANCE

ftiperformance.com | 386-736-5816

TH400 ALUMINUM PRO-MOD DIRECT
DRUM WITH CLUTCH PACK

- 36-element Pro Mod sprag
- Five high-carbon intermediate clutches
- Four intermediate steels
- Custom intermediate pressure plate
- Clutch hub bearing
- Drum spring retainer snap ring



POWERGLIDE 7-BOLT PUMP

- Bolt-in stator tube
- Seven-bolt high-flow pump
- Ringed shaft

POWERGLIDE COMPLETE
U-BUILD-IT KIT

- Complete gasket and seal kit with Teflon rings
- Five thick reverse clutches and steels
- Powerglide high-flow filter
- Direct drum clutch and steel pack
- New performance lined low-gear band
- Drum, pump, case, governor support, and tail bushing



TH400 U-BUILD-IT KIT

- Complete TH400 gasket and seal kit with Teflon rings
- New modulator with tube
- Case bushing, pump bushing, center support bushing, front planetary bushing, stator support bushing, rear output shaft bushing
- Second gear band
- Intermediate wave plate
- Three intermediate thick clutches
- Two intermediate steels, forward wave steel

MCLEOD RACING

mcleodracing.com | 714-630-2764



MCLEOD TUNER SERIES NISSAN 400Z ALUMINUM FLYWHEEL

- CNC-machined from 6061 T6 aluminum
- Replaceable steel friction plate
- 1045 steel hardened ring gear
- McLeod continues to grow in the sport compact market with the addition of the Nissan 400Z aluminum flywheel



MCLEOD ADVENTURE SERIES JEEP MAX MASS FLYWHEEL

- Higher mass (heavier) to prevent stall/pull the engine down easily like OEM flywheel
- Reduces strain on engine with increased tire size
- Street or off-road



TUNER SERIES MINI MAG 7.25 CLUTCH

- Available for the B- and K-series Honda
- Friction material designed to endure the required slippage of drag racing
- High clamp-to-wear ratio
- Low moment of inertia
- Available in single, twin, and triple disc



TUNER SERIES STREET SUPREME 2JZ TO CD009 SINGLE DISC CLUTCH KIT

- Street or track cars with moderate bolt-ons
- High clamp load pressure plate
- High torque six-puck carbotic disc
- Superior holding power
- Smooth engagement

DEVELOPMENT • RACE • PRODUCTION • RESTORATION



ABRADABLE POWDER COATINGS™

Now 3 locations to better serve you!

LINE2LINE (HQ)

4866 White Lake Rd.
Clarkston, MI 48346
248-625-3052

LINE2LINE SouthEast

580 Prison Camp Rd.
Campbell, SC 29322
864-473-0637

LINE2LINE West

1406 #4 Industrial Way
Gardnerville, NV 89410
775-782-4060

Improve new parts



Restore used parts

WWW.LINE2LINECOATINGS.COM

Leafspring
SLIDERS
VIRTUALLY NO BINDING

When a Fraction of a Second is the only thing keeping you from the Winner's Circle...

Replace old factory rubber bushing shackles with Calvert's LEAFSPRING SLIDERS. Features metal rollerized bearings for reduced friction and ease of movement through spring travel during drag race hard acceleration.

Logan Femeau
1972 Plymouth Duster Hemi
Caltracs
Calvert Split Mono Leafsprings
Calvert Sliders

Calvert Racing Sliders available to fit:
Calvert Springs
GM Factory Springs
S10 Factory Springs

burnin' up the track
CALVERT RACING

ASK A TECH:
661-728-9600
Hours: M-F 8am-4:30pm PST
CalvertRacing.com

PRI MEMBER BENEFITS

10%

OFF WEBSITE PRICING



JOIN TODAY!

VISIT:
PERFORMANCERACING.COM/MEMBERSHIP



PENSKE

RACING SHOCKS

3 SHOCK SETUP SUPPORT

DESIGNED TO WIN

f @penskeshocks
 @penske_racing_shocks
 @penskeracingshocks



WWW.PENSKE SHOCKS.COM
610-375-6180

BOOTH #1625



SILVER SPORT TRANSMISSIONS

shiftsst.com | 865-609-8187



1979-1993 FORD FOX BODY MANUAL CLUTCH PEDAL CONVERSION KIT

- Add a manual clutch pedal to the existing automatic pedal box
- Complete kit, including a clutch safety switch and illustrated, thorough instructions
- Compatible with cable clutch or aftermarket hydraulics



TKX FRONT SHIFT KIT

- Moves the shifter tower to a bench-seat-friendly 12.68 inches behind the bellhousing
- Short, precise throws
- Compact design
- Double trunnion design with all steel and aluminum parts, no plastic



RX7 TREMEC MAGNUM KIT

- 700 lb-ft torque rating
- 7,800 rpm shifts
- Fully synchronized, even reverse



TREMEC TR-4050 2WD

- Built for work trucks and heavy-duty vehicles
- Low first and reverse gears
- Short, smooth shifts

SUNCOAST PERFORMANCE

suncoastperformance.com | 850-864-2361



TH400 BILLET TORQUE CONVERTER

- Zero-Drag Lockup Technology for constant oil flow, less parasitic loss, and quicker throttle response
- SunCoast Pro-Loc XL Sprag gives 15% increase in bearing roller surface
- Three-pass design for individual control of the converter circuit
- 7075 T6 billet aluminum plate versus round bar



10R80 BOLT-TOGETHER TORQUE CONVERTER

- Bolt-together design for easily replacing internals
- Zero-Drag Lockup Technology for constant oil flow, less parasitic loss, and quicker throttle response
- SunCoast Pro-Loc XL Sprag gives 15% increase in bearing roller surface
- Three-pass design for individual control of the converter circuit



SUNCOAST 10L90 TORQUE CONVERTER

- Bolt-together design for easily replacing internals
- Zero-Drag Lockup Technology for constant oil flow, less parasitic loss, and quicker throttle response
- SunCoast Pro-Loc XL Sprag gives 15% increase in bearing roller surface
- Three-pass design for individual control of the converter circuit



8HP70/90 SNAKE CHARMER

- Manufactured and tested in-house at SunCoast
- Has been 5.83 in the 1/8 and 9.09 at 149 in a 2018 Hellcat using the 8HP90 platform
- Both the 8HP80 and 8HP90 torque converters are available in a variety of stall speeds



FLATOUT GASKETS
SEAL WHERE
OTHERS DON'T

BOOTH #1335

847.837.9200
FLATOUTGROUP.COM



Racing Transmission Accessories
Hi-Performance Applications

Home of the Original
"TRICK STICK"



Fill Tube Assemblies
for automatic transmissions
Over 40 models in stock

Custom Applications
made to your specs

Engine Oil Dipstick Assemblies
now available for most applications
www.mastaperformance.com

(248) 685-8710 • FAX (248) 685-3710

PRI MEMBER BENEFITS

10% DISCOUNT OFF PURCHASE



JOIN TODAY!

VISIT:
PERFORMANCERACING.COM/MEMBERSHIP



PRI MEMBER BENEFITS

ACCESS TO MEMBERSHIP ADVANTAGE PROGRAM



JOIN TODAY!

VISIT:
PERFORMANCERACING.COM/MEMBERSHIP



SECTION 2 | CHASSIS, DRIVELINE & SUSPENSION

TUBEWORKS INC.

tubeworks.com | 951-784-7900



TUBEWORKS BILLET RACE-DRIVE LOCKING DIFFERENTIAL

- Fitment for all 3.812-inch and 4.00-inch bearing Ford 9-inch type cases
- "Detroit style" function but smoother action
- User rebuildable, spline swappable 35, 40, 45, 2-3/8-inch 36 spline
- Single wheel or dual one-way drive options
- Made in the USA



TUBEWORKS DUPLX PINION SUPPORT

- 300+% bidirectional pinion thrust capacity than any 9-inch/10-inch support made
- Direct fitment for 100% of all Ford 9-inch/10-inch type third members
- Low rolling resistance with massive improvement in gear position control
- Proven through 2019, 2020, 2021 Championships and countless event wins; made in the USA



TUBEWORKS BILLET FIVE-AXIS DEVELOPED TRUE 10-INCH GEAR

- Balanced drive/coast involute hybrid tooth form
- Full radiused gear root geometry
- Gear geometry developed on 10.5-inch pitch, ring trimmed to true 10 inches for fitment
- Replaceable pinion nose stem
- Made in the USA



TUBEWORKS CROSSTIEX LOW AND HIGH PINION THIRD MEMBER

- Direct fitment for Ford 9-inch/9.5-inch/10-inch platform
- Fits every existing 9-inch, 9.5-inch, and 10-inch gear set made
- Developed for "True 10" diameter gear sets
- Trophy Truck, NHRA, and street reliability for 1,000–5,000 hp range
- Available in 35, 40, 45, and Jumbo 2-3/8-inch 36 spline spools/lockers; made in the USA

MICKEY THOMPSON



TIRES & WHEELS

**UNDISPUTED
TRACTION**

**FOR STREET, DRAG,
TRUCK, AND EXTREME
OFF-ROAD.**

**SEE US AT
BOOTH # 3733**

MICKEYTHOMPSONTIRES.COM
AMERICAN OWNED SINCE 1963. 





ATI PERFORMANCE PRODUCTS 6R80E CHEVY BOLT-IN STREET/ STRIP TRANSMISSION PACKAGE

- The first true externally controlled, six speed transmission package for Chevrolet vehicles
- Easy highway cruising, seamless downshifts, transbrake, and second gear (2.34) leave options through multiple templates tuned independently of the engine management system
- SFI flexplate, converter, bellhousing, 6R80 transmission, and external controller all designed to work together with a conventional Chevy or LS-based engines

Contact: 410-298-4343
atiracing.com

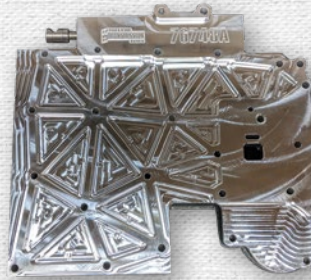

AUTOMATIC TRANSMISSION DESIGN BILLET 4L60E REVERSE MANUAL VALVE BODY

- All-new billet aluminum 4L60E RMVB
- Reverse manual shift pattern
- Full engine braking
- Overrun clutch supported for durability
- TCC in 4th gear
- No ECU control required
- Fits any 4L60E/4L65E/4L70E case
- Made in-house in the USA

Contact: 262-251-7777
autotransdesign.com



BERNHEISEL RACE CARS M SERIES METRIC CLIP

- Tubular steel chassis crafted to the same measurements as the classic OEM chassis

Contact: 717-926-7473
bernheiselracecars.com



BILLET SPECIALTIES REDLINE RACE SERIES WHEEL

- The Redline Race Series Wheel brings strength and style to the street and strip
- 6061 T6 forged center
- Spun 6061 T6 Rim
- Recessed bolt pad for weight reduction
- Tested to SFI 15.3 standards
- Available in polished and black finishes

Contact: 708-588-0505
billetspecialties.com



BOKER'S INC. SHIM STACKS

- Exact, consistent thicknesses; inside and outside diameters satisfy a wide range of automotive applications
- Custom manufacturing options available with outside diameters ranging from 0.080 inches to 12 inches and material thicknesses of .005 inches to .190 inches

Contact: 612-729-9365
bokers.com



BUZZE RACING WIDE 5 BEARING SPACER ASSEMBLY

- Anodized
- Raised rib with longer locking set screw to help prevent stripping of threads
- Adjustable in one-thousandth (.001) of an inch increments
- Reusable
- Made in the USA

Contact: 704-664-8907
buzzeracing.com

American Made. American Strong.

Backyard Buddy 4-Post lifts



WIDE BUDDY
8,000 lbs. capacity

CLASSIC EXTRA TALL
7,000 lbs. capacity



CLASSIC BUDDY
7,000 lbs. capacity



WORKFORCE BUDDY
8,000 lbs. capacity



Scan for special offers on Backyard Buddy and Advantage Lifts collections.

Visit www.AdvantageLifts.com or call 763-300-5730



CARTER AMERICAS LLC NMB E-TYPE BEARINGS

- NMB E-Type monoball and rod end bearings maximize performance for suspension and steering systems
- Optimize torque so it is predictably smooth and consistent in all directions
- Increase load rating by up to 35%
- Increase temperature rating by almost 200%
- Bearings are in USA stock

Contact: 888-501-5444
carterbearings.co.uk



CECOMP ELECTRONICS F22BBL DIGITAL PRESSURE GAUGES

- $\pm 0.25\%$ accuracy, $\pm 0.1\%$ optional
- Eight memory locations for tire readings, push button zero
- Rugged design with white LED display
- Available rubber boot for additional protection

Contact: 847-918-3510
cecomp.com

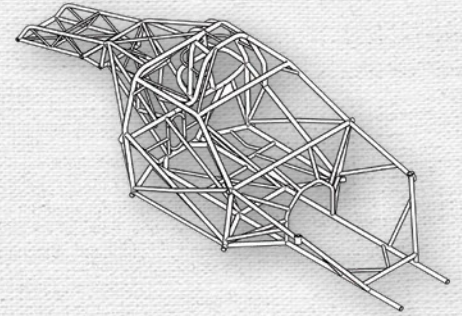

CHASSIS ENGINEERING DRAG RACING CHASSIS COMPONENTS

- Manufacturers and distributors of high-quality drag racing chassis components
- Four links
- Ladder bars including the OUTLAW Series
- Strut front ends
- Roll cages
- Home of the 6.0 Eliminator XTR Chassis

Contact: 561-863-2188
chassisengineering.com



COKER TIRE CO. INC. PHOENIX 10.5/28.0-15(S)

- Phoenix Bias-Ply Slick 10.5/28.0-15 targets the 10.5-inch tire market
- Stiff sidewall to move forward faster with less tire wrap-up for faster reaction times
- 10.5-inch tread width/28 inches in diameter
- Perfect for stock suspension drag, bracket, no prep cars
- Variety of sizes and compounds are available
- Made in the USA

Contact: 800-251-6336
coker.com



CREATIVE RACING PRODUCTS, LLC CHASSIS HEIGHT MEASURING SYSTEM

- Measures ride height and scale weight wirelessly
- Integrated with the top scale manufacturers in auto racing
- Tall-boy, standard, and custom height roll-offs available
- Fastest, most consistently accurate, and easiest to use chassis set up tools

Contact: 203-910-4432
creativeracing.com



DOMINATOR RACE PRODUCTS DOM 1400 DOMINATOR PIT KIT

- Complete body pit repair kit
- Plastic body bolt washers available in 12 different colors (also available with aluminum body bolt washer in black or mill finish)
- Includes large and small head, exploding rivets, nylon and flange nuts, hex head and Allen head bolts, fender bolt clips, and steel backing washers

Contact: 419-923-6970
dominatorraceproducts.com

177% BETTER

NEAPCO PERFORMANCE SERIES
**DOMINATES
THE COMPETITION**



WE OUTPERFORM OUR COMPETITION, SO YOU CAN OUTPERFORM YOURS!

1310 SERIES LOW-CYCLE FATIGUE U-JOINT COMPARISON

Neapco Part# 1-0153P



Made in
the U.S.A.

ULTIMATE STRENGTH
(pure brute strength)

LOW-CYCLE FATIGUE
(off-road & racing endurance)

HIGH-CYCLE FATIGUE
(everyday use & towing endurance)



Scan
for all
testing
data by
driveline
series

Neapco Performance Series Universal Joints are tested and proven to outperform the leading competitor's premium u-joint. Go **Beast Mode** with Neapco.

neapco
PERFORMANCE SERIES

NeapcoAftermarket.com

BEAST MODE
STRENGTH & ENDURANCE



EATON PERFORMANCE PRODUCTS MASTER DIFFERENTIAL INSTALL KIT

- Install your new Eaton Performance differential using the install kit that has the best components, designed to deliver the best performance for your vehicle
- Includes all necessary components to complete differential installation
- Premium bearings and components ensure long life and quiet operation
- More than 70 models to fit today's vehicles

Contact: 800-328-3850
eatonperformance.com



FIVE STAR RACE CAR BODIES DIRT LATE MODEL PLASTIC QUARTER PANEL

- 32001-27351-xR
- Replace aluminum with longer lasting high-impact lightweight plastic
- High-impact plastic resists chipping, denting, bending to last longer than traditional aluminum quarter panels
- Flame-retardant material with high-heat distortion temperature
- Same weight per sq. ft. as .040-inch aluminum
- Available in four colors: black, blue, red, and white

Contact: 262-877-2171
fivestarbodies.com



FLURO-GELENKLAGER GMBH ROD ENDS AND CONNECTING RODS FOR MOTORSPORTS

- Housing forged from heat-treated steel to 42CrMo4, nickel plated with high polish finish
- Ball made to bearing steel 100Cr6, hardened, ground, polished, chromium plated
- Preloaded bearing fit, "zero" tolerance
- Insert made to stainless steel to 1.4571 with PTFE liner bonded to the inner surface, alternatively of extra heavy-duty steel to 45S20, zinc plated

Contact: 0049742893850
fluro.de



GRAF GEARBOXES HONDA K SERIES SEQUENTIAL TRANSMISSION

- Fully sequential transmission available for all types of use from street performance to full drag, including rally, road race, drift, off-road and more
- AWD and FWD setups with power levels from 800 hp to 1,500 hp+
- Featuring proprietary Reinforced Hardened Cast Aluminum housing technology for the most demanding race environments while maintaining a racer budget

Contact: 786-264-1706
grafgearboxes.com

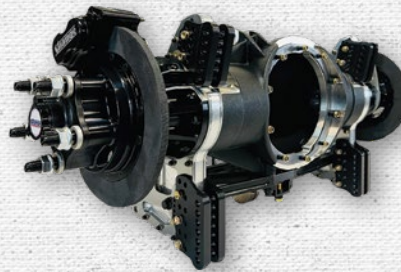

HAMMER CONCEPTS AND DESIGNS LLC 1/8-INCH ADJUSTABLE HOUSING BRACKETS

- Patented brackets allow for fine-tune adjustment of link bars in any drag car
- Solutions available for a wide range of suspension types and budgets

Contact: 641-980-8332
hammerconceptsanddesigns.com



HOOSIER RACING TIRE NATIONAL LATE MODEL TIRE

- Only two sizes and three compounds
- Consistent, durable compounds
- Pre-molded large cross block pattern
- Designed for no-groove, no-sipe rule

Contact: 574-784-3152
hoosiertire.com



QUANTUM
M A C H I N E R Y G R O U P

NEW

SPECIAL PROMOTIONS

THE ALL-NEW SIEGMUND SYSTEM 16 IMPERIAL SERIES BUNDLES
HAVE WHAT YOU NEED TO GET THE JOB DONE

System 16 – Imperial Series

Siegmund® Welding Table
Professional Extreme 8.7
2x 3' x 4' 88 Piece Bundle
2x 12" Square U-Shape

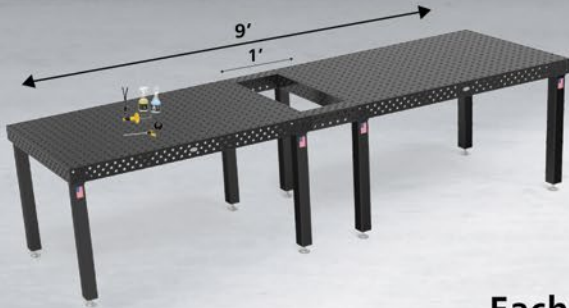

\$6,750

Item No. US168125.X7-12IN

System 16 – Imperial Series

Siegmund® Welding Table
Professional Extreme 8.7
2x 3' x 4' 88 Piece Bundle
2x 48" Square U-Shape

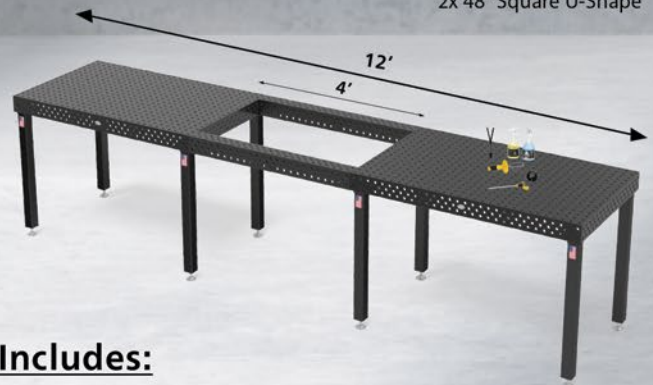

\$7,550

Item No. US168125.X7-48IN

Each Bundle Includes:



ONLY A FEW LEFT IN STOCK

siegmund®

System 16 – Imperial Series

Siegmund® Welding Table
Professional Extreme 8.7
3' x 4' 34 Piece Bundle



\$2,999

Item No. US168125.X7

WWW.WELDINGTABLES.COM
(704) 703 - 9400

WANT TO SEE SIEGMUND IN ACTION?
VISIT US AT THE PRI 2022 TRADE SHOW
BOOTH #3309 & #5359



HOTRODS BY HAVLIKS LLC CLASSIC, MUSCLE, HARDCORE STREET AND DRAG RACE FABRICATION

- Specialists in projects ranging from classic numbers-matching builds to full custom cars
- Street, track, and everything in between

Contact: 319-826-2066
hotrodsbyhavliks.com

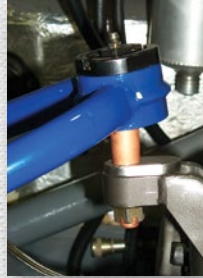

HOWE RACING ENTERPRISES INC. HOWE PRECISION BALL JOINTS

- Howe Precision Ball Joints provide low resistance, a captured ball for precise front-end alignment, and the largest selection of interchangeable stud sizes
- A proprietary process allows the stud to bend while the ball resists wear
- Made in the USA with fewer pieces and no plastic internal parts for superior durability

Contact: 989-435-7080
howeracing.com



IDIDIT LLC IDIDIT PERFORMANCE QUICK RELEASE STEERING HUBS

- The IDIDIT Quick Release Steering Hub comes in three-bolt, five-bolt, and six-bolt designs with a centering pin design that ensures center alignment every time
- All IDIDIT Performance pull-type Quick Release Steering Hubs come in a two-piece design with center shaft and hub and are SFI certified

Contact: 517-424-0577
ididit.com



JAZ PRODUCTS INC. 22-GALLON MAN O' WAR FUEL CELL

- 22-gallon polyethylene fuel cell in black powder coated steel can
- Billet style cap with dipstick and bolt-in plastic flapper for rollover protection
- AN-10 90-degree fuel pickup with bat-wing, AN-8 90-degree return, and AN-8 90-degree tip-over valve vent
- Measures 21-1/4 inches L x 18-7/8 inches W x 19 inches D

Contact: 805-525-8800
jazproducts.com



JRI SHOCKS LLC JRI SHOCKS ST/08 PRODUCT LINE

- A variety of adjustability options available: Non, Single, Double, Triple, and 4-Way
- Multiple piston options for maximum grip and to create the curve you are looking for
- Lower hysteresis resulting in improved response time
- Maintains better performance and longevity over long runs

Contact: 704-660-8346
jrishocks.com



KING RACING PRODUCTS KING BILLET DIRECT MOUNT FRONT HUBS

- Manufactured to last
- Made from aerospace 7075 aluminum alloy
- Strong and super lightweight
- The new removable hub seal design lets you service your inner bearing without damaging or having to replace your hub seal on either the right or left hub
- Two-piece design makes parts easily replaceable

Contact: 559-739-1515
kingracingproducts.com



WHERE ULTIMATE PERFORMANCE BEGINS

FRAM ULTRA SYNTHETIC® OIL FILTERS

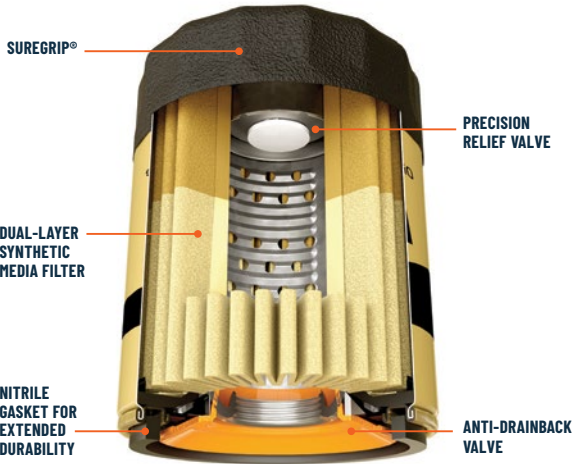

FRAM Ultra Synthetic® oil filters provide ultimate protection for new and older engines. Optimized for use with synthetic oil, the dual-layer synthetic media filter provides 99%+ filtration efficiency* and up to 20,000 miles of protection. When you want proven performance, you need ultimate filtration. Find your fit at FRAM.com.



*FRAM Group testing of average filter efficiency of PH8A, 3387A and 4967 or equivalent FRAM TG or EG models under ISO 4548-12 for particles greater than 20 microns.

FRAM®

FRAM.COM

Trusted since 1934



MME MOTORSPORT GEAR ACTUATOR WITH INTEGRATED VALVES

- Two-way gear actuator with integrated valves (with adjustable travel)
- Up to 1005N force available at 8 bars (max 10 bars)
- Compact package for tight places
- With optional position sensor and/or integrated closed loop gear control unit
- Plug-and-play brackets available for various gearboxes

Contact: +386 41979000
mme-motorsport.com



MPI USA, INC. D3 STEERING WHEEL

- Dirt racing aluminum steering wheel
- New weatherproof textured oval shaped foam grip + rear finger bumps
- New extreme grip RG material covering with new MPI Orange crossed stitched finish
- New black anodized post-machined padded spokes

Contact: 704-208-4344
maxpapisinc.com



NEAL CHANCE RACING CONVERTERS BOLT TOGETHER CONVERTER COMPONENTS

- NCRC is offering converter builders new billet bolt together drive covers and multiple fin angle pump sides in 8-, 9-, and 10-inch sizes
- Allows you to install your components to offer your customers a top-of-the-line bolt together converter without having to purchase a CNC machine or expensive raw materials

Contact: 316-542-9869
racingconverters.com



NEW ENGLAND GEAR POLISHING LLC NEGP REM MICRO POLISHED GEARS AND BEARINGS

- NEGP polished wheel bearings and differential bearings in stock
- NEGP micro polishes your ring and pinions, transmission gears, crankshafts and more
- Cut friction and heat in street cars, race cars, bikes, ATVs
- Smoother is faster!

Contact: 860-807-5513
negearpolishing.com



NEXEN TIRE AMERICA NEXEN ROADIAN ATX

- Nexen Tire's newest all-terrain off-road capable tire for the professional or the enthusiast
- Proven in Baja, Championship Off-road and Ultra 4 Series
- Combining all-weather, all-terrain, all-road, and all-around great performance
- Three-ply sidewalls provide excellent durability and rigidity, while the tread performs in all conditions

Contact: 330-671-6445
nexentireusa.com



NITROUS EXPRESS / SNOW PERFORMANCE SNOW PERFORMANCE MUSTANG FUEL HAT

- Aftermarket performance with OE fitment for return-style fuel systems
- OE reliability using Walbro fuel pumps in two- and three-pump configurations
- CNC-machined T-6061 aluminum construction
- Viton chemical resistant O-rings for leak-free fitment
- Gas & ethanol compatible (but not methanol)
- Made in the USA

Contact: 940-767-7694
nitrousexpress.com



pureTM
drivetrain solutions



A NEW AGE IN TRANSMISSIONS

GRAND REVEAL AT PRI 2022



SCAN ME

PUREDRIVETRAINSOLUTIONS.COM



NUKE PERFORMANCE AB AIR JACK 90 COMPETITION ON-BOARD AIR JACKS

- Lightweight motorsports air jacks
- As low as 8 BAR/120 PSI work pressure
- Works with common air compressors
- Complete kits with two, three, or four units
- Four-piece kit lifts 3,540 lbs. at as low as 120 PSI
- Total lift height of 251 mm/9.88 inches
- Made in Sweden

Contact: 0046-763392525
nukeperformance.com



PERFORMANCE ENGINEERING & MANUFACTURING PEM CARBON FIBER DRIVE SHAFT

- PEM offers carbon fiber drive shafts for circle track, drag racing, street performance, and off-road
- Sizes from 2.25 inches OD to 5.31 inches OD
- Available U-joint sizes from 1310 series through 1480 series
- Extensive testing for the last two years has given us a baseline for your needs

Contact: 636-629-6200
pemracing.com

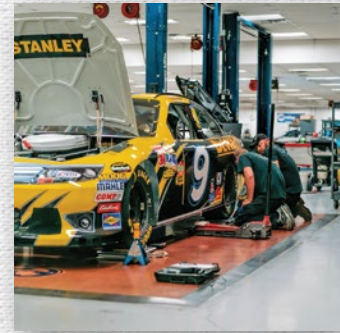

PRECISION EPOXY PRODUCTS EPOXY SURFACE PLATE

- The most accurate surface plate available
- Complete your shop with this irreplaceable set-up tool and give your other set-up tools the ability to perform with the utmost reliability

Contact: 770-489-0340
precisionepoxy.com



QA1 Q SERIES TWIN TUBE SHOCKS

- QA1 has redesigned its top-performing twin tube shocks to further enhance performance, consistency, and rebuild-ability
- Updated seal kit provides improved performance and consistency—especially in high-rebound applications—to reduce piston rod wear and improve leak resistance
- Improved serviceability due to a new gland design with a hyperscrew port and relief cuts that make shocks easier to bleed

Contact: 952-985-5675
qa1.net



QUARTER MASTER STREET PERFORMANCE OPTIMUM-SP DUAL DISC CLUTCH KITS

- Less rotating mass is significantly lighter than the stock unit
- Billet construction and 100% rebuildable design for years of service
- Compatible with OE hydraulic bearings
- Each clutch and flywheel kit incorporates engineering know-how derived from the rich Quarter Master racing heritage

Contact: 847-540-8999
quartermasterusa.com



QUARTER-MAX CHASSIS & RACING COMPONENTS THREADED ADJUSTABLE STRUT MOUNT KIT

- Gives you total control over the front ride height and the travel in the front struts
- Increase or decrease the amount of travel in the front struts
- Great tuning adjustment for weight transfer
- Allows last-minute tuning even in the staging lanes
- Manufactured in-house in the USA

Contact: 309-343-7575
quartermax.com



Wireless Ride Heights & Scale Weights.

Measure wirelessly with patented Creative Racing Bluetooth® technology, and pair your scales with Standard, Tall Boy or Custom roll offs. See why leading race teams, chassis builders, and auto manufacturers have elevated their standard of precision with the quickest, most consistently accurate, and easiest to use chassis setup tools.



QUICK PERFORMANCE GUN-DRILLED & LIGHTENED AXLE FLANGES

- Gun-drilling available for 35- or 40-spline axles will save up to 5 pounds of rotating weight
- Lightweight flanges will save an additional pound of rotating weight

Contact: 515-232-0126
quickperformance.com



RADIUM ENGINEERING LLC SPARE TIRE FUEL CELL

- Motorsports grade competition 10.5-gallon fuel cell featuring a circular shape that fits in most common spare tire areas
- FIA and SFI approved
- Available with Radium's surge tank fuel pump system and dry-break filling accessories

Contact: 971-783-8850
radiumauto.com



RAYBESTOS POWERTRAIN LLC MUSTANG/CAMARO 10R80, 10L80 E CLUTCH TORQKIT

- Performance upgrade beyond the OE design with increased clutch count
- Features six revolutionary performance GPZ frictions, seven steels with full 15-tooth count, and .101 selective steel to increase performance, durability, and towing capacity

Contact: 765-359-2554
raybestospowertrain.com

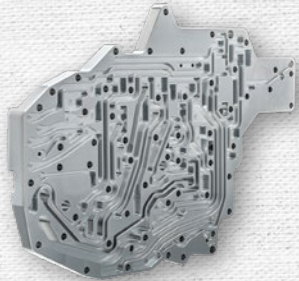

REVMAX TORQUE CONVERTERS 68RFE ZEROFLEX BILLET CHANNEL PLATE

- The only truly flat billet channel plate
- 6061 billet aluminum construction, deep critical worm tracks, .0003 flatness across the entire plate
- No visible or perceptible machining marks or stepovers, ensuring no chance of leaks due to machining marks
- Large radius machining on the filter cutout increases rigidity, yet allows use of a stock filter assembly

Contact: 877-780-4334
revmaxconverters.com



ROD END SUPPLY ROD ENDS

- Available in mild steel, chromoly, and aluminum
- Self-lubricating and self-cleaning
- Nylafiber matrix race

Contact: 913-530-7536
rodendsupply.com

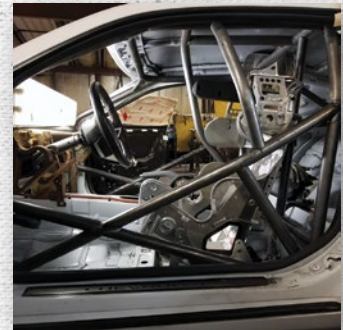

S&W RACE CARS & COMPONENTS INC. S&W 10-POINT ROLL CAGE

- Made in the USA
- Over 2,800 direct fit domestic and import make, model and style listings
- Custom cages can be bent to customer specifications
- Around the dash, through the dash, and runner style configurations are available for most vehicles
- Chromoly, EWS or DOM steel

Contact: 610-948-7303
swracecars.com

INDUSTRY LEADING INNOVATION ICONIC PERFORMANCE

Thank you for your continued loyalty and business



Let's make it a Powerful 2023!





SCHULTZ PRODUCTS SCHULTZ RACING FUEL CELLS

- Schultz Ultimate Racing Fuel Cells meet SF128.3 Approvals
- Lightweight nylon reinforced construction with optimal wear resistance
- Schultz Ultra Racing Fuel Cells meet NASCAR 2000 Approvals
- Lightweight ultra-thin Kevlar reinforced
- Fill plates have been reengineered, including aluminum spring loaded rollover fill protection and O-ring sealed bulkheads

Contact: 845-742-9244
schultzproducts.com



SLADE SHOCK TECHNOLOGY G2 COPPERHEAD DOUBLE ADJUSTABLE

- 100% original in-house design
- A true double adjustable with a wide range of low-speed adjustment for chassis tuning
- No expensive mechanisms inside the shaft to replace when damaged means it's far cheaper to repair
- Amazing repeatability time after time when adjusted

Contact: 704-232-1127
sladeshocktechnology.com



STEINJAGER "OFF ROAD" HEIM BUILDERS KIT 1.25 X 1.00

- Universal rod end builders kit
- Kit includes: (4) 1.25-12 x 1.00 RH heat-treated chromoly rod ends, (4) 1.25-12 x 1.00 LH heat-treated chromoly rod ends, (4) 1.25-12 RH jam nuts, (4) 1.25-12 LH jam nuts, (4) 1.25-12 RH weldable thread bung for 1.500-inch ID tubing, (4) 1.25-12 LH weldable thread bung for 1.500-inch ID tubing, (16) 1.00-inch to 3/4-inch high misalignment spacers

Contact: 309-772-3163
steinjager.com



STRANGE ENGINEERING INC. TWO-PIECE STEEL AND STAINLESS STEEL ROTORS

- Two-piece floating slotted rotors
- 6061-T6511 billet aluminum hat
- Cog and ring system secures rotor while allowing for thermal expansion variances between aluminum and steel
- Slots improve airflow, assist in warpage prevention, and reduce weight
- 4-1/2-inch, 4-3/4-inch and 5-inch uni-lug bolt circles for both 1/2-inch and 5/8-inch studs
- Eliminates crack formation common to bolt retention designs

Contact: 847-663-1701
racestrange.com



SWIFT SPRINGS USA INC. 8-INCH LENGTH 5-INCH OUTER DIAMETER FRONT SPRINGS

- New rates: 525 and 600
- Proprietary wire HS5TW
- Requires less shock rebound
- Better turn-in
- Loads faster

Contact: 909-393-8623
swiftsprings.com



TITAN 7 LLC TITAN 7 T-S5

- Fully forged by 10,000 tons of force
- Super light and strong
- Rigid spoke tracers for maximum camber stiffness
- The first to use reinforced inner rim flange
- Beadseat knurling for maximum traction

Contact: 626-823-0947
titan-7.com

GOODYEAR[®]

MORE DRIVEN[®]



DRAG CAR
TIRE GUIDE



FROM THE PROFESSIONAL LEVELS OF MOTORSPORT AND
DRAG RACING, TO THE TOP SPEEDS OF THE SALT FLATS,
GOODYEAR RACING TIRES ARE MADE FOR WINNING TROPHIES!

PRI
PERFORMANCE RACING INDUSTRY

Come discover the "Goodyear Experience" at
the 2022 PRI show and visit us in booth 3733.

GOODYEAR
Racing

PRI MEMBER BENEFITS

\$15
OFF \$75
PURCHASE
5.11 

JOIN TODAY!

VISIT:
PERFORMANCERACING.COM/MEMBERSHIP



PRI MEMBER BENEFITS

10%
ANY 2 OR 5 DAY
WELDING WORKSHOP



JOIN TODAY!

VISIT:
PERFORMANCERACING.COM/MEMBERSHIP



TOTAL TRANSMISSIONS CHICAGO
6L80E BILLET TORQUE
CONVERTER

- Hand-brazed turbine with heat-treated input splines
- Balanced and pressure tested
- Custom stall speeds
- Billet, non-billet and diesel applications available

Contact: 708-493-0160
totaltransmissions.com



TRANSGO PERFORMANCE
6L80 TOW & PRO
REPROGRAMMING KIT

- Patent-pending calibration maintains factory shift feel at light-to-medium throttle with progressively firmer upshifts through WOT
- Elevated max line and a more aggressive pressure curve deliver quick, clean, firm shifts with increased holding capacity without tuning
- 1-2 and 2-3 hard-throttle tire chirping shifts with simple HP tuning
- All drop-in components

Contact: 626-443-7451
transgo.com



TRANSMISSION
SPECIALTIES INC.
TURBO 400 FORWARD
DRUM AND INPUT SHAFT

- Heavy-duty CNC machined billet steel
- Lightweight design (2 1/2 pounds lighter than OEM drum)
- Oversized bore where the shaft meets the drum for added strength
- Available in three input shaft styles (300M, Aermet, 35 spline "oversized" Aermet)

Contact: 610-485-9110
tsirace.com

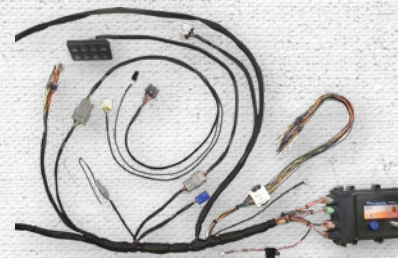

WIRING SPECIALTIES
COMPLETE S13/S14 CHASSIS
REPLACEMENT HARNESS
WITH SOLID-STATE PDM FOR
NISSAN S13/S14 PRO SERIES

- Complete replacement body wiring harness
- Pre-programmed 15-circuit solid-state Power Distribution Management Unit
- Choice of 8-position CAN keypad or use your OEM S13/S14 stalks (for an additional charge) to control lights, turn signals, wipers, etc.
- Directly terminated signal connections based on chassis

Contact: 860-799-6579
wiringspecialties.com



   [MBQuart.com](https://www.MBQuart.com)
#MUSICDEFINED

Fuel Outdoor Adventures with MB Quart Honda Talon Tuned Audio Kits!

Bringing the highest quality of audio and playback while immersing listeners into deeper layers of sound - Honda Talon Powersports UTV Kits deliver a concert experience wherever the adventure demands.

The MBQT-STG5-1 is a STAGE 5 Honda Talon Tuned Audio System that features an AM/FM/Bluetooth LED source unit controlling two amplifiers powering four coaxial speakers, an 8-inch subwoofer in a sealed enclosure and all necessary mounting panels and harnessing.

Every Honda Talon Powersports UTV Kit offers incredible power with LOUD sound, undistorted and clean listening, and durability allowing for more freedom and exploration in every off-road adventure.

Take in more from sound through Music. Defined. levels of listening around every turn and corner within your Honda Talon vehicle. Bring out more from every adventure with Honda Talon Powersports UTV Tuned Audio Kits.



LIFEShield



Bluetooth® Connect



Plug & Play Installation



SECTION

3

RACING COMPONENTS, ACCESSORIES & SERVICES

From racing helmets and firesuits to oils and lubricants, trailers and awnings, simulators and much more, here you'll find a wide range of new products and services for teams, drivers, and vehicles. Whether at the shop, in transit, in the pits, or on track, these items serve both professional and grassroots teams alike by providing top-of-the-line solutions in speed, safety, and convenience.

ASHCROFT INC.

ashcroft.com | 800-328-8258



ASHCROFT S1 PRESSURE TRANSDUCER

- Designed for high-volume manufacturing; high-quality, low-cost, quick lead times
- All stainless-steel thin film pressure CVD-based sensor technology for exceptional cycle life and repeatability
- Outstanding shock and vibration resistance, IP65 and/or IP67 levels of ingress protection



ASHCROFT G2 AND G3 PRESSURE TRANSDUCERS

- G2: Field-proven sensor and all stainless steel wetted materials provides excellent overpressure capability and durability
- G3: All 316L stainless steel wetted materials for installations in pressures as low as 100 in. H₂O along with superior corrosion resistance—perfect companion to G2 for low, vacuum, and absolute pressure applications
- Both G2 and G3 highly configurable with wide selection of pressure connections, outputs and electrical terminations



ASHCROFT GV PRESSURE TRANSDUCER

- All-welded sensor and pressure connection designed for high vibration applications
- Field-proven polysilicon thin film pressure sensor provides excellent overpressure capability and outstanding durability despite substantial shock and vibration
- Highly configurable with wide selection of pressure connections and electrical terminations



ASHCROFT DG25 DIGITAL PRESSURE GAUGE

- All welded sensor and pressure connection provide reliable vehicle support in pit lane
- Available in a wide variety of pressure ranges, connections and optional features, including backlit display and rubber protection boot
- Provides menu-driven features including unit select, min/max hold and dampening



THE MOST
RESPECTED
NAME IN FUEL CELLS FOR
50+ YEARS

LET US TRANSFORM YOUR
FUEL SYSTEM
DREAMS INTO REALITY

DETAILED CAD MODEL TO PAPER TEMPLATE

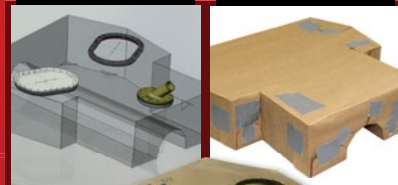

TO FINISHED PRODUCT



ATLRACING.COM @atracingfuelcells
800-526-5330 MADE IN THE USA - Ramsey, New Jersey USA

**Tired of
Running
Hot?**

Call Today!
1-800-842-5166

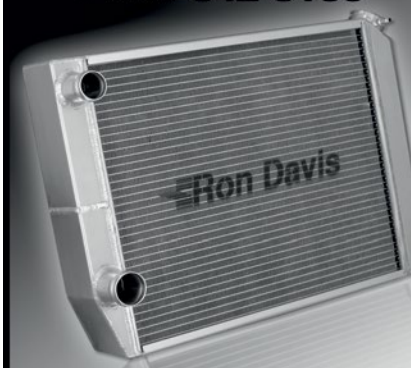

Ron Davis
RACING PRODUCTS
High Performance Radiators

All Types of Racing
Lightweight Aluminium Construction
Pressure Tested at 30 PSI
Furnace Brazed Cores
100% Tig Welded
6061-T6 Outlets
Glendale, Arizona

RonDavisRadiators.com

PRI MEMBER BENEFITS

ACCESS TO
MEMBERSHIP
ADVANTAGE
PROGRAM

JOIN TODAY!

VISIT:
PERFORMANCERACING.COM/MEMBERSHIP



PRI MEMBER BENEFITS

\$15
OFF \$75
PURCHASE

5.11

JOIN TODAY!

VISIT:
PERFORMANCERACING.COM/MEMBERSHIP



AUTOROD CORPORATION

autorod.net | 732-851-5095



ARC 4001RPM-ECU

- ARC four-switch control module with backlit kill switch
- Rollbar mount with a black faceplate and a carbon fiber dipped case
- Includes four ground triggered relays

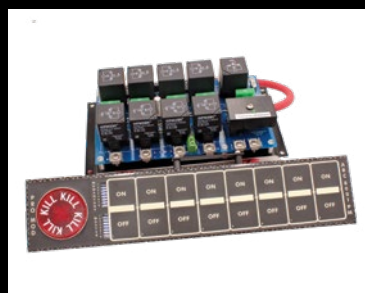

ARC 8004RPM-P

- ARC eight-switch control module with backlit kill switch
- Rollbar mount with a black faceplate and a carbon fiber dipped case
- This unit includes ARC's exclusive Oil Pressure Control. If the engine loses oil pressure, it will automatically kill the ignition to prevent excess engine damage



ARC 8003 SD AND 8004 SD

- ARC carbon fiber dipped cases with a white faceplate (8003) and a black faceplate (8004)



ARC V-NET MOUNTS

- ARC VM-01 RacePak V-Net module mounts
- Available in panel mount or rollbar mount

MAC'S TIE DOWNS

macstiedowns.com | 800-666-1586



MAC'S CHASSIS STABILIZER

- The perfect complement to your Mac's tie-down straps
- Reduces wear on chassis components, struts, springs, torsion bars, and on-board computers
- Made to order in Idaho using a proprietary, heavy-duty elastic rubber compound
- Available in round (inflates to 10 inches) or rectangular (inflates to 4 inches) shape
- Includes 6-foot hose kit and gate valve



MAC'S PIVOT AND ADAPTERS

- The easiest way to remove and install your vehicle's engine and transmission
- No chains, cables, ineffective cranks, firewall interference
- Mounts easily to most two- and four-barrel carburetor intake manifolds
- Tilts up to 35 degrees with the turn of the lead screw
- Adapter plates available for most engines
- New adapter available for the Ford Godzilla engine



MAC'S GRAB & GO TIE-DOWN PACK

- Mac's light-duty tie-down straps keep gear and cargo secure
- Includes four pairs of straps: 6 feet, 8 feet, 10 feet, and 12 feet along with soft loops for motorcycles, coolers, etc.
- Premium nylon webbing material is rated to 4,000 pounds
- Choose nine colors: black, blue, red, yellow, lime green, purple, silver, orange, and pink
- Made to order in Idaho



MAC'S DRAGSTER TIE-DOWN PACK

- Developed specifically for dragsters with oversized rear tires and narrow front tires
- Rear tire sizes available for dragsters, nostalgia dragsters and dirt sprint cars
- Front and rear net packs sold separately or combined into one complete pack
- All packs available with or without anchor points
- Choose six colors: black, blue, red, yellow, lime green, and pink
- Made to order in Idaho

MOCAL

Fluid Control Systems

Oil Coolers - air or water to oil
Oil Thermostats - inline/sandwich
Oil Take-off's, Oil Filter Mounts
Electric Pumps & Fans
Plumbing - Hose & Fittings
-AN and Metric sizes



Importer & Distributor:

BAT Inc.

7630 Matoaka Rd

Sarasota, FL 34243

941.355.0005

www.mocalusa.com

SPINTRIC

EVERYTHING DRY SUMP!



CNC Machined
Dry Sump Tanks



Atmospheric Vent
Cans Patented!

WWW.SPINTRIC.COM 916-652-5282

*** ROBINS ***

New! New! INTRODUCING RUBi-Hard Premium New! New!
3 Angle Valve Seat inserts and tooling



RUBi-hard
Premium 3-Angle Inserts

- Carbide Pilots (Live + Fixed)
- 3 Angle Inserts
- Ball Heads & Tool Holders
- Custom Production Tooling



Inventors of
Spring-Free Tooling
(US Patent)



RUBi-Smart
New Series



Get min. 50% more life compared to any other 3-angle inserts.

Anthony Debar (941) 600-7176
Eastern USA & Canada

ROBINS
RUBi-Hard
RubiHard.com

Jeff Marchion (907) 224-9922
Western USA

PRI MEMBER BENEFITS

10%

DISCOUNT OFF PURCHASE

JOIN TODAY!

VISIT:
PERFORMANCERACING.COM/MEMBERSHIP



PRI MEMBER BENEFITS

PREFERRED PRICING ON SHIPPING AND LOGISTIC SOLUTIONS



The Official Logistics Partner

JOIN TODAY!

VISIT:
PERFORMANCERACING.COM/MEMBERSHIP



MAXIMA RACING OILS

maximausa.com | 619-449-5000



ASSEMBLY LUBE

- Lubricant designed to form a durable protective film on moving components
- Formulated with 2X Zinc anti-wear system. Activates at both high and low temperatures. Prevents metal-to-metal contact after startup
- Non-foaming formulation easily dissolves into both mineral and synthetic oils



ASSEMBLY GREASE

- High-performance assembly grease that excels in a multitude of heavy- and light-duty applications
- Unique calcium sulfonate complex soap thickener combines with a proprietary additive system to deliver thermal stability and extreme pressure performance
- Oil-soluble formulation won't clog filters and provides protection against corrosion, water washout, and wear



PERFORMANCE BREAK-IN OIL

- Mineral-based engine oil specifically formulated for breaking in engines with flat tappet camshafts, roller elements and where maximum anti-wear performance is needed
- High ZDDP formulation combines the highest quality mineral base stocks with a shear-stable polymer system to provide fast and effective ring seal
- Proprietary additive system utilizes a complex, low temperature activating 2X Zinc system that ensures immediate and lasting protection



CHOOSE YOUR LEVEL OF PERFORMANCE

- Mineral-based engine oil developed formulation utilizes a 2X Zinc system combined with stay-in-place chemistry for protection during every run
- Semi-synthetic, ester-based engine oil designed to ensure optimum protection and peak performance for race and hot rod engines
- Full-synthetic, triple ester racing engine oil designed to ensure maximum performance while providing maximum protection under the most severe conditions

MAXX-D TRAILERS

maxxdtrailers.com | 903-784-8059

MAXX-D
TRAILERS



A6X DROP-N-LOAD AIRBAG CAR HAULER

- 9,990 lbs. GVWR, 20-foot or 24-foot deck lengths
- Airbag suspension for smooth ride
- Raises and lowers the steel-floor deck with the push of a button
- Low loading angle of 7 degrees
- Full-length running boards and split-tail rear
- Can come with a rock shield, e-track, custom wheels, in-floor lights, and other options



T5X 10K POWER TILT TRAILER

- 9,990 lbs. GVWR, 20-foot to 24-foot deck lengths
- Tilts entire deck with the push of a button
- Can come with steel floor and e-track for easy tie downs
- Has a full 83 inches between the fenders for hauling wide-body cars
- Can come with a 102-inch wide deck and drive over fenders



N6X 10K TUBING CAR HAULER

- 9,990 lbs. GVWR, 20-foot to 24-foot deck lengths
- Easy-to-use 6-foot slide-in ramps with stoppers
- Full-length running boards on the sides
- Toolbox for storage up front
- Can be equipped with a rock shield and e-track
- Angled corners up front for a sleek look
- Split-tail in the rear for easy tie downs



N5X 7K TUBING CAR HAULER

- 7,000 lbs. GVWR, 20-foot to 24-foot deck lengths
- Easy-to-use 6-foot slide-in ramps with stoppers
- Full-length running boards on the sides
- Toolbox for storage up front
- Can be equipped with a rock shield and e-track
- Angled corners up front for a sleek look
- Split-tail in the rear for easy tie downs



PRODUCTS:

- Sprint Car Filters
- Street/Muscle Car Filters
- Custom Filters



Contact:

Jon Maddocks
1-800-263-8660
jon@otrfilters.com

OTR Filters
663 Woodward Avenue
Hamilton, ON L8H 6P3

www.otrfilters.com

SCHUMANN'S PERFORMANCE WET SUMP OIL PUMPS

NEWEST PATENTED DESIGNS!

- "140 PRO MAX", No Load Bypass
- "PADDLE WHEEL", Gear to Gear SBC, BBC, OLDS, Pontiac

ENERGY RECOVERY

- 30 to 40% Less Energy To Operate
- Turbo Charged Intake Cycle
- No Atmospheric Pressure
- Vacuum Pan Friendly
- "ANNULAR FLOW" LS Engine Technology

"WET SUMP OIL PUMPS" WITH A DRY SUMP ATTITUDE!

Call Verne at PO Box 128
1-563-381-2416 Blue Grass IA 52726

WWW.SCHUMANNSSALESANDSERVICE.COM

BRASWELL

AMERICA'S FINEST COMPETITION CARBURETION
CARBURETORS FOR CHAMPIONS

Dirt Track Oval Track
Drag Race Road Course
Off Road Marine

- More Top End Power
- Broader Power Band
- Smoother Acceleration

MORE THAN COMPLETE CARBURETORS

Premium Parts - Engine Building Programs - Rebuild Kits

(520) 579-9177

SALES@BRASWELL.COM

WWW.BRASWELL.COM

PRI MEMBER BENEFITS

10%

DISCOUNT OFF PURCHASE



JOIN TODAY!

VISIT:
PERFORMANCERACING.COM/MEMBERSHIP



PRI MEMBER BENEFITS

DISCOUNTS!

ON



AND OTHER GREAT BRANDS

JOIN TODAY!

VISIT:
PERFORMANCERACING.COM/MEMBERSHIP



RACE RAMPS

raceramps.com | 800-213-5883



SCALE RAMPS: 7.8° APPROACH ANGLE, SET OF 2

- Each ramp supports 1,500 pounds; 6,000-pound overall vehicle weight capacity
- 7.8° approach angle allows low-profile vehicles to easily mount scales
- Ideal for track days, auto shops, or personal garages
- 10-inch maximum tire width
- Anti-slip/skid stays in place on any surface
- Made in the USA and constructed of 100% solid, high-density foam



7-INCH H TRAILER RAMP: 5.5° APPROACH ANGLE, SET OF 2

- Lighter, safer approach to loading race cars or low-profile vehicles
- Each ramp supports 1,500 pounds; 6,000-pound overall vehicle weight capacity
- Each lightweight ramp weighs only 15 pounds
- 12-inch maximum tire width
- Made in the USA and constructed of 100% solid, high-density foam
- Each ramp has a built-in carrying strap



5-INCH H HOOK NOSE EXTRA WIDE RACK RAMP: 6.4° APPROACH ANGLE, SET OF 2

- 20-inch width works with tires up to 18 inches wide
- Each ramp supports 1,500 pounds; 6,000-pound overall vehicle weight capacity
- Each lightweight ramp weighs only 15 pounds
- 6.4° approach angle with 3-inch hook nose and 5 inches of lift height
- Made in the USA and constructed of 100% solid, high-density foam



12-INCH SUPERCAR WHEEL CRIBS, SET OF 2

- Ideal for fluid changes, general maintenance, detailing, or at a car show
- Each crib supports 1,500 pounds; 6,000-pound overall vehicle weight capacity
- Each lightweight crib weighs only 9 pounds
- Supports 16 inches wide and 24-inch – 30-inch diameter tires
- Won't slide, scratch, or damage your floors
- Achieve a full vehicle lift with two sets
- Made in the USA and constructed of 100% solid, high-density foam

SCHAEFFER'S SPECIALIZED LUBRICANTS

schaefferoil.com | 800-325-9962



MICRON MOLY RACING OIL 20W-50

- Resists mixing with alcohol-based fuels
- Extra zinc to protect flat-tappet cam engines and other components from wear
- Extra protection for when engines are operating at higher temperatures
- Keeps engines clean from harmful debris and buildup
- Reduces oil consumption



SUPREME 7000 SYNTHETIC PLUS RACING ENGINE OIL 10W-30

- Extra zinc to protect flat-tappet cam engines and other components from wear
- Excellent high-temperature, high-shear performance
- Substantially reduced oil consumption
- Extra protection for when engines are operating at higher temperatures
- Friction modified with our proprietary Micron Moly and Penetro to reduce wear from metal-to-metal contact



PENETRO 90 PENETRATING OIL

- Prevents thread stripping, busts through rust
- Protects against corrosion, rust, and abrasive particles
- Frees stuck and rusted parts
- Doesn't affect seal materials or coatings
- Excellent on Heim joints, wheel studs, and weight jack bolts that have become difficult to operate



SUPREME GEAR LUBE 75W-90

- Reduces operating temperatures
- Enhanced thermal and oxidative stability and durability
- Excellent extreme pressure properties to protect against wear
- Compatibility with all types of seals
- Enhanced gear, bearing, and seal cleanliness

World Leader In Temperature Sensors!



Motorsports
Engine Dyno
Industrial
Aerospace



1-800-348-4678
Sales@exhaustgas.com



sales@cvracingproducts.com



MOTOROLA
SOLUTIONS

NO MORE STATIC!!!

Complete
Digital System
ONLY \$899

Extra Crew
ONLY \$399

SameDay Shipping with
Phone and Live Video
Tech/Sales Support



www.sampsonracing.com / 866.396.7231



ph: (440) 354-0777 · 1 (800) 752-9850

www.cometic.com





ACCELO RACEWEAR ACCELO CHAMPION SUIT

- SFI 3.2A Certified suit
- Double-layer aramid construction
- Stretch panels at movement areas
- Includes fluorescent and premium colors
- Custom-tailor fitted
- Unlimited embroidery
- Any custom design

Contact: 510-990-0099
acceloracewear.com



ADVANCED FUEL DYNAMICS E-SENSE HIGH FLOW E85 FLEX FUEL CONTENT SENSOR

- High-flow performance alternative to GM/Continental fuel content sensor
- Massive flow rate, up to 12 times fuel flow rate of GM/Continental sensor
- Modular fittings
- Easily interchangeable fittings including 3/8 inch QC, 1/2-inch QC, -6AN, -8AN, -10AN, -12AN
- Outputs: content, fuel temperature, fuel pressure
- Patent pending
- Made in USA

Contact: 866-902-3835
advancedfueldynamics.com



AED METAL PRODUCTS & SUPPLIES METAL PRODUCTS & SUPPLIES

- Tubing, sheet, plate, and bar
- 4130 chromoly, aluminum, DOCOL R8, mild steel, alloy steel, stainless steel, and titanium
- High-performance streamline tubing manufactured in-house
- Production saw cutting and shearing, tube bending and forming, polishing, tumbling, and deburring
- Part identification, worldwide shipping, SO-90012015 Certified
- "The World's Fastest Metal Distributor"

Contact: 317-334-0569
aedmetalproducts.com

PATENTED CERAMIC LUBRICANT

TESTED #1 FOR EXTREME PRESSURE & FILM STRENGTH

TriboDyn® Lubricants

ENGINEERED TO:

- ✓ Perform Under Extreme Pressure & Heat
- ✓ Enhance Motor Performance & Horsepower
- ✓ Form a Ceramic Coating Under Extreme Conditions
- ✓ Improve Fuel Mileage
- ✓ Reduce Operating Temperature
- ✓ Reduces Wear & Increases Engine Life



www.TriboDyn.com
Mooresville, North Carolina | USA
+1 704.266.3577 | info@TriboDyn.com

Visit TriboDyn® at the 2022 PRI Show
Booth # 3024 | Yellow Hall
MADE IN THE USA

TriboDyn®
LUBRICANTS



**ALPINESTARS
GP RACE V2 SUIT**

- Available in Boot cut and Cuff cut designs
- Boot cut design complies with SFI 3-2 A/5 homologation
- Cuff cut design complies with FIA 8856-2018 homologation
- Multi-layer lightweight suit incorporating knitted stretchable panels for maximum comfort and excellent breathability
- “Regular” fit design

Contact: 310-891-0222
alpinestars.com



**AVIORACE SRL
AUTOSPORT CONNECTORS**

- AvioraceUSA (US branch of Aviorace) is an authorized distributor of TE Connectivity Autosport Connectors, a manufacturer of motorsport high-performance sensors, electronics, and accessories for racing vehicles
- The company offices and warehouse are located in Troutman, NC

Contact: 704-402-7802
aviorace.it



**BALLENGER MOTORSPORTS INC.
AFR500CAN AIR FUEL RATIO
MONITOR KIT—WIDEBAND O2
SYSTEM**

- The AFR500CAN takes the AFR500V2 industry benchmark performance and adds the convenience of plug-and-play digital CAN Bus messaging
- Offers configurability for CAN-enabled systems with specific presets for HP Tuners, EFILive, MoTeC, AEM, Haltech, and more
- PC software is included for programmability of CAN or OBDII message structure

Contact: 804-915-7201
bmotorsports.com

CNC Heads, Blocks, Parts

One Machine, One Fixture

“One minute we are doing a cylinder head and 10 minutes later we have a block in the machine”

*Tony Salloum,
VAC Motorsports*



Call (814) 353-9256 x101
www.centroidperformanceracing.com

**Videos
Online!**





BELLAVER AUTOMOTIVE DIAGNOSTICS/WDIFL RACING WDIFL.COM

- Since 1998, the largest drag racing history and photo site on the planet

Contact: 714-321-7075
wediditforlove.com

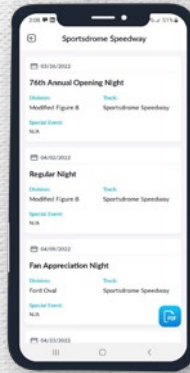

BKSK ENTERPRISES, INC. RACETRACK CONNECTION APP

- New motorsports app for tracks, drivers, and race fans
- It is free and available in your app store

Contact: 502-370-7740
racetrackconnection.com



BLUD LUBRICANTS GEAR OIL

- 100% synthetic limited-slip red racing oil
- For differentials, transmission, and wet clutch
- Exceeds GL-5 specifications
- Exceptional thermal stability
- Formulated for clutch-type limited-slip differentials
- Outstanding shear stability
- Extended drain intervals
- Exceeds OEM warranty requirements

Contact: 888-239-3946
bludlubricants.com

DESIGNED TO OUTPERFORM EXPECTATIONS

SEE US AT PRI #3413

Increase tractability with these serious components for FORD Mustang



12050
2015 - 22 FORD MUSTANG
LIGHT-WEIGHT REAR TOE LINK
(Fixed Length)

72370
2015 - 22 FORD MUSTANG
REAR CAMBER ARM
(-2.0° - +3.0° Camber)

xAxis™
Sealed Flex Joint

These forged aluminum rear camber arms for Mustang (#72370) yield superior strength, less weight, high rate rubber bushings & camber adjustment, while the toe link (#12050) features less weight over OE and the benefits of xAxis™ sealed flex joints for performance you will feel.

SPC
PERFORMANCE®
Feel The Difference!

By  Specialty Products Company®
©2022 Niwot Corp. dba Specialty Products Company®

1.800.525.6505

specprod.com





**BOOSTANE
BOOSTANE RACE FUELS**

- The leaders in octane engineering have turned their expertise and developed a niche line of race fuels to meet the demands of those who need even more octane and performance
- 110 Octane Leaded
- 116 Octane Leaded
- E85 Pure
- UTV98 Octane Oxygenated
- 109 Octane Unleaded

Contact: 513-265-8216
boostane.com



**BOSCH MOTORSPORT
DISPLAY DDU 11**

- 6.5-inch graphic color display
- 12 user-configurable display pages
- 18 multi-configurable LEDs
- Up to 1,500 channels
- Internal logging
- 4 GB memory standard
- IP67 rated

Contact: 248-876-1000
bosch-motorsport.com



**BOYCE INDUSTRIES
TUBE BENDING SERVICES**

- Mandrel tube bending
- Aluminum, mild steel, alloy steel, and stainless steel
- 3/4-inch to 4-inch OD round
- 1-inch to 4-inch square and rectangular
- 3-inch to 4-inch oval tube
- Oval tubing for exhaust systems
- High-performance streamline tubing
- End forming, roll forming, rolled ring, and light fabrication
- Over 1,000 different mandrel bends and bend combinations

Contact: 708-345-0455
boyceindustries.com

VISIT US AT PRI **BOOTH #2001**
GREEN HALL • INDIANAPOLIS, IN • USA | DECEMBER 8-10, 2022

TOP STREET PERFORMANCE is a supplier of high quality street and strip performance products. Our experience and alliances with a network of quality parts manufacturers allows us to offer an ever-expanding line of premium products at affordable prices, all backed by our one year warranty. With extensive offerings in ignition, cooling, electrical, intake manifolds, and more, we've got parts for everything from hot rod to LS. Whether you've got classic muscle or a fuel injected street rod, we've got the parts you need.

QUALITY. PERFORMANCE. PERIOD.®



CONNECT WITH US!   

(562) 926-5858 | WWW.TOPSTREETPERFORMANCE.COM





BUTLERBUILT MOTORSPORTS EQUIPMENT SPEEDWAY ADVANTAGE II

- Butlerbuilt's best seat for asphalt late models, modifieds, and other asphalt stock car applications
- Available in 15 inches, 16 inches, 17 inches, 18 inches, or custom sizes
- 20-degree layback for stock car applications
- Available in SFI 39.2 Spec

Contact: 704-784-1027
butlerbuilt.net



CHAMPION OIL RACING POWER STEERING FLUID

- Full synthetic racing power steering fluid
- Formulated to meet the specific performance demands of today's high-performance racing power steering systems

Contact: 660-890-6241
championsusechampion.com

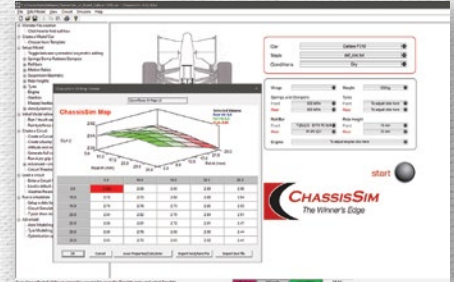

CHASSISSIM TECHNOLOGIES CHASSISSIM

- Vehicle dynamics simulation software with race data, lap timer, and driver in loop tools
- Get the maximum possible performance out of your race car
- Arrive at the circuit confident and prepared

Contact: +61 425-219-375
chassissim.com

BELL RACING SAFETY APPAREL

Available early 2023

Call 1 (800) 237-2700 to
learn more.



BELLRACING.COM





**CHILLOUT SYSTEMS
CYPHER PRO ULTRA-LITE
CARBON FIBER MICRO
COOLER**

- Lightweight carbon fiber
- Weighs only 84.5 ounces
- Compact in size at only 7.87 inches x 4.09 inches x 6.90 inches
- Dual fans move 350 CFM of air

Contact: 954-406-0442
chilloutsystems.com



**CORROSION TECHNOLOGIES
MUD SLIDE**

- Ready-to-use mud repellent; no mixing
- Keeps mud, oil, and exhaust from clinging to your racing body panels, suspension components, and graphics
- Premium ingredients ensure the highest possible ease of mud release from vehicles and components
- Safe on graphics and paint
- Great for race cars, off-road vehicles, ATVs, and UTVs
- High purity product will not clog spray nozzles

Contact: 972-271-7361
corrosionx.com



**D-A LUBRICANT CO. INC.
PENNGRADE 1 20W-50**

- A product of D-A Lubricant Company, PennGrade 1 High Performance Oil is "The Original Green Oil"
- With its tenacious clingability and enhanced levels of zinc and phosphorous chemistry, PennGrade 1 gives your hard-working engine the performance and protection it demands and deserves

Contact: 317-923-5321
penngrade1.com

**PRI
Booth
5201!**



CNC Boring Mill
ACF200 CNC

**Fast
Accurate
Automatic**



CNC Surfacer
RP1400 CNC

Comec, Inc.

www.comecus.com

info@comecus.com

800-887-6076





DATA HERE-TO-THERE AUTOMOTIVE SHOP-IN-A-BOX

- Turnkey ecommerce store for any type of automotive business or vehicle type
- With Data Here-to-There Shop-in-a-Box, all you need is your distributor account and we can help you expand your business and start selling parts online faster and for less investment than you may have thought possible

Contact: 780-907-3231
dataheretothere.com



DAYTONA SENSORS WEGO III - DUAL SENSOR - LAMBDA WIDEBAND KIT 112006

- Accurately monitor both engine banks (V8)
- Dual display and dual sensor—lab grade wideband
- Lambda display
- Built-in data-logging
- 96-inch wiring
- Waterproof

Contact: 386-322-7390
daytona-sensors.com



EIDE INDUSTRIES, INC. TRANSPORT TRAILER AWNINGS AND CANOPIES

- Custom transport trailer awnings and canopy systems make a statement on and off the track
- Designed for racing events, mobile marketing, and hospitality suites
- Made in the USA

Contact: 562-402-8335
racecanopies.com

HIGH PRECISION GEARS

*for your most
demanding needs*

- » Gear Cutting
- » Gear Grinding
- » CNC Turning
- » CNC Milling
- » ID & OD Grinding



www.IPMINC.com
320.656.1241

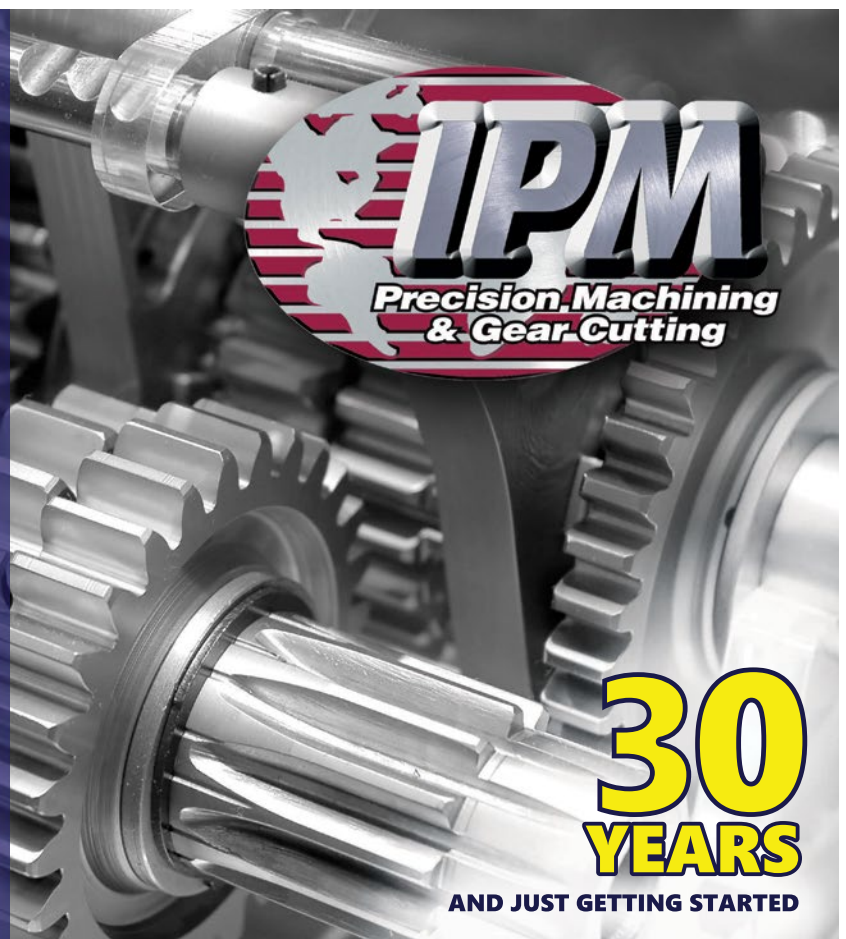

**30
YEARS**

AND JUST GETTING STARTED



EQ SYSTEMS
HYDRAULIC BUMPER PULL TONGUE JACK

- For bumper pull and towable trailers with a lifting capacity of 6,000 lbs. and 16 inches of stroke
- Equipped with manual override screw drive pump in case of power failure
- It also has simple rocker-style switch control and built-in key for safe lockout of the jack to protect against theft

Contact: 574-264-3437
equalizersystems.com



EVOLVE LUBRICANTS, INC.
ECORSA MOTORSPORT NON-PETROLEUM RACING OIL

- 100% synthetic high-performance non petroleum hydrocarbon base; made in the USA
- Extreme high-temperature, high-shear stability at 302° F
- Leading high-zinc formulations provide excellent wear resistance for high-rpm, high compression applications for extended engine life
- Advanced non-petroleum protection and thermal performance encourages increased power and lower operating temperatures

Contact: 831-630-4097
evolvecube.com



EXHAUST GAS TECHNOLOGIES INC.
SUPER X EGT SENSORS FOR DYNAMOMETERS

- With popularity of turbo/supercharging, extreme dynamometer testing facilities requested an EGT sensor that delivered accurately, repeatably, and, of course, dependably
- With the great success of the Super X EGT in NHRA Fuel classes, Super X Probes will be the last set you need
- Available for all dynos
- Every sensor has certifications to prove accuracy
- Prices starting at \$99

Contact: 909-548-8100
exhaustgas.com



*Quality Isn't Expensive...
It's Priceless*



VALVE GUIDES • VALVE SEATS • KEEPERS/LOCKS
SPRING CUPS & BASES • LIFTER BORE BUSHINGS
SPRING RETAINERS • LS TRUNNION KIT UPGRADES



PRODUCING THE MOST CONSISTENT COMPONENTS. PERIOD.

www.cheprecision.com | 805-499-8885





FEDPRO
TUB O' TOWELS HEAVY DUTY CLEANING WIPES, TW90

- 10-inch x 12-inch heavy-duty wet cleaning wipes
- The strongest and largest wet paper towel cleaning wipe; no water required
- Removes heavy stains others won't including grease, tar, ink, paint, permanent marker, wax, scuffs, food, drinks, and more
- Moist towels are gentle on hands and skin
- Contains lanolin, aloe vera, and vitamin E

Contact: 216-464-6440
fpcintl.com



FIGSPEED, LLC
RACING TIRE COVERS

- Available for door cars and dragsters
- Vinyl construction with five suction cups included
- 44-inch width, 35-inch height

Contact: 702-463-7760
figspeed.com



FLIS PERFORMANCE LLC
MAZDA MX-5 CUP RACE SERIES

- The Idemitsu Mazda MX-5 Cup presented by BF Goodrich is a single-make motor racing championship sanctioned by the International Motor Sports Association in the United States

Contact: 386-256-7021
flisperformance.com

ONE GOOD TURN
DESERVES ANOTHER



COME VISIT US AT **PRI** BOOTH 728



RACK & PINION CRADLE KITS



STEERING COLUMNS
NEW LIGHT WEIGHT RACING COLUMNS
NOW AVAILABLE!

THE MICROSTEER
ELECTRIC POWER ASSISTED STEERING

FOR MORE INFO VISIT OUR WEBSITE AT:
FLAMINGRIVER.COM
OR CALL US AT: **800-648-8022**



FLITZ INTERNATIONAL LTD.
FLITZ PASTE POLISH FOR METALS, FIBERGLASS, PLASTIC AND PAINT

- The Swiss Army Knife of polishes
- American know-how, German engineering
- Cleans, de-oxidizes, polishes, and protects
- Safe on stainless steel, aluminum, chrome exhaust, and more
- Restores faded paint, fiberglass and acrylics
- Leaves a durable finish with tough protection
- Non-abrasive, non-toxic, & non-flammable
- Proudly made in the USA

Contact: 262-534-5898
flitz.com



FLUIDLOGIC
FLUIDLOGIC HYDRATION SYSTEMS

- FluidLogic Active Hydration is used by top-level motorsports athletes to stay hydrated behind the wheel
- Just press the steering wheel-mounted microbutton, and water is delivered right to your lips
- FluidLogic connects to your helmet using quick-connect magnetic connections and is completely adjustable via our IOS app

Contact: 310-725-1720
fluidlogic.com



FOGGIT
HIGH PERFORMANCE FOGGING OIL

- Unique formula coats internal components inside your engine that can begin to form surface rust in as little as a few days without protection
- Protects cylinder walls and internal surfaces from corrosion while lubricating cylinders to help prevent damage when starting after storage

Contact: 800-283-1433
foggit.com



BETATOOLSUSA.COM

+1 717.449.5044



FOLDS DOWN FOR EASY STORAGE

EFFORTLESS TRANSPORT.
EASY STORAGE.

The Beta C27S folding tool cart is the perfect companion for indoor and outdoor jobs. It's unique patented design guarantees an effortless transport. The C27S folds easily allowing you to take it on mobile jobs when needed. The Thermoplastic worktop has six built-in tool trays for max organization while working on your various projects.

- TWO DRAWERS WITH BALL BEARING SIDES FOR TWO-WAY OPENING
- TWO FIXED CASTORS AND TWO STEERING CASTORS WITH BRAKE
- THERMOPLASTIC WORKTOP WITH SIX BUILT-IN TOOL TRAYS



AVAILABLE COLORS: C27S-O C27S-G C27S-R C27S-N C27S-B

Beta Tools USA is a subsidiary of BETA UTENSILI S.P.A. Sovico (MB) - Italy



FUEL FACTORY FUEL FACTORY F-14

- Used in high-compression applications: off-road, Super Late Model, large displacement drag race
- Extra detonation protection formulated and dyno tested by industry-leading engine builders
- Consistency from start to finish

Contact: 269-330-6759
fuelfactoryusa.com



GFH INSULATION HEAT SHIELDING/LAGGING

- Superior workmanship
- Durable systems
- Lightweight, yet robust materials
- Reduce heat, improve gas flow
- Protection up to 1000° Inconel and stainless steel options

Contact: 317-241-0868
gfhinsulation.com



H.B. FULLER/GORILLAPRO PROFESSIONAL GRADE ADHESIVES, SEALANTS, AND LUBRICANTS

- Made for machine and engine repair
- Professional grade anti-seize lubricants, epoxies and urethanes, instant adhesives, thread lockers, gaskets and sealants, and retaining compounds
- H.B. Fuller and Gorilla Glue have combined technology, innovation, and unbridled brute strength to deliver the next evolution of solutions for countless mechanical fixes

Contact: 888-676-7763
gorillapro.com

LET GIANT FINISHING
"THE METALS FINISHING
EXPERTS" HELP YOU CREATE/IMPROVE
YOUR FINISHING PROCESS. WE RUN
SAMPLE PARTS
FREE OF CHARGE. LET
US HELP CREATE A RECIPE
WITH THE RIGHT MACHINE,
MEDIA, & CHEMISTRY TO
FINISH YOUR PARTS
CONSISTENTLY EACH AND
EVERY TIME. CALL US TODAY.

GIANT
FINISHING, INC.



**HAGERTY
MOTORSPORTS INSURANCE**

- Affordable motorsports insurance options that fit how and when you hit the track so you can focus on what lies ahead
- Off-track motorsports insurance for non-street legal cars and motorcycles, and street-legal race cars
- Single-day track day insurance
- Annual non-competitive track insurance
- Commercial motorsports insurance

Contact: 800-922-4050
hagerty.com



**HAVEN TECHNOLOGIES INC.
ISOTUNES FREE AWARE**

- Offers situational awareness and protection from harmful noises
- Background noise-reducing microphone for clear communication in loud environments
- ANSI-certified 25 dB NRR
- IP67 durability for dust and waterproof protection
- Bluetooth 5.2 connectivity
- 13 hours of battery life (up to 25 additional hours with charging case)

Contact: 317-740-0419
isotunes.com



**HP TUNERS
MPVI3**

- HP Tuners' latest gen OBDII interface, the MPVI3, is the ultimate diagnostic and calibration tool—and the perfect gift for any gearhead/tuner
- From diagnosing check engine lights and standalone data logging to building custom tunes, use an MPVI3 and VCM Suite software to unlock even more vehicle performance
- Gift an MPVI3 this season at www.hptuners.com

Contact: 224-900-0269
hptuners.com

SERDI

See us at PRI 2022 - Machinery Row - Booth 5201

2.0 ES



3.5



**PROFILE
CNC**



NEW!!

4.5



1-800-447-3790

www.serdi-usa.com

information@serdi-usa.com

Most Accurate Seat & Guide Machines in Existence!



INEARZ SPORT UH-1 CUSTOM FIT UNDER HELMET EARPHONES

- Custom fit for improved sound and comfort
- Low profile for under helmet use
- Available in soft silicone, durable acrylic, or our industry exclusive hybrid of silicone and acrylic called FusionSoft
- Built using the latest digital manufacturing technology for improved fit
- Available in mono or stereo configurations

Contact: 407-339-2422
inearzsport.com



ISC RACERS TAPE CUSTOM PRINTED LOGO TAPE

- Custom Printed Logo Tape advertises your logo and/or contact information on packaging tape while ensuring that your packages arrive at their final destination intact
- Custom Printed Logo Tape is available for print on a range of ISC packaging tapes used for carton sealing

Contact: 215-295-2300
racerstape.com



JIFFY-TITE MOTORSPORTS QUICK CONNECT/ DISCONNECT PRODUCT LINE

- 100% leak-proof—when connected or disconnected, both connectors prevent fluid leakage
- High flow, minimum restriction
- Available for virtually any fuel, water, oil, or transmission application
- Maximum operating pressure of 200 PSI
- Sockets are available in black or gold anodized finish
- Jiffy-tite is part of the Oetiker brand

Contact: 716-681-7200
jiffy-titemotorsports.com

Permatex

HIGH TEMPERATURE GASKET MAKERS

GET TRAINED TODAY ASE Education Foundation



**KB TRAILER SALES
CUSTOM CAR HAULER**

- Easiest and premier destination to design and build your next car, motorcycle or toy hauler
- We know the importance of a personalized sales experience
- Goal is to help our customers find and design the perfect trailer for their specific and unique demands

Contact: 216-930-5510
kbtrailersales.com



**KIRKEY RACING
FABRICATION INC.
THE 80 SERIES KIT**

- Introducing the all-new 80 Series Kit for 2023
- Constructed with MIG and TIG welded .100 inches and .190 inches thick 5052-grade aluminum
- Featuring 20° layback and three-piece design for maximum vertical shoulder height adjustment
- Head restraint has energy-absorbing impact padding and adjusts vertically
- Available in five sizes: 14 inches, 15 inches, 16 inches, 17 inches, 18.5 inches

Contact: 800-363-4885
kirkeyracing.com



**KRJ RACE PRODUCTS
HANS DEVICES**

- HANS, Simpson hybrids, and Schroth head-and-neck devices

Contact: 317-496-6767
krjraceproducts.com

**DURAMAX
DIESEL PISTONS**

New expanded Duramax line, all 3 generations including the LML.



 UEM has a selection of 010" reduced compression height pistons for most applications.

 ASK about **ULTRATHERM^{CM}** in-house thermal barrier crown coating as an "add-on" option.

NEW UEM EXCLUSIVE - Duramax Rings PVD coated with Chrome Boron Nitrite (CrBN) THE BEST ring coating for long service life and HI OUTPUT applications. **IN STOCK!**



UNITED ENGINE & MACHINE

1040 Corbett Street • Carson City, NV 89706 | 1.800.648.7970 | www.UEMPistons.com





LAMIN-X PROTECTIVE FILMS ROLL CAGE PAINT PROTECTION

- Protect your roll cage tubes from scrapes, scuffs, and chipping with our invisible paint protection film
- Just trim to fit from our 4-inch x 30-foot roll and keep your cars looking professional and new

Contact: 706-955-0677
lamin-x.com



LAT RACING OILS NEW PRO X ATF

- Pro X ATF is our newest product for 2023
- Extreme engine torque requires a fluid that's going to give more positive clutch engagement in your automatic transmission
- LAT now offers four ATFs to help the racer win races
- Extreme temperature control, positive clutch engagement, high torque converter efficiency

Contact: 714-585-3247
latracingoils.com



LIFELINE FIRE & SAFETY SYSTEMS ZERO 360 SFI 17.3 SPRINT CAR 5 LBS. MECHANICAL + SINGLE AUTO ACTIVATION

- Novec 1230 gas system knocks down fires fast and directly dissipates heat
- Automatic fire detection and deployment
- Secondary manual activation
- Constant Discharge Technology allows for effective fire suppression in full 360° bottle orientation
- Lightweight system weighing in at just 7 pounds
- Lightest SFI 17.3 Sprint Car System on the market

Contact: 540-251-2724
lifeline-fire.com

WE DELIVER A PATTERN OF EXCELLENCE



Hoosier Pattern continues to be an industry leader by setting the bar high to exceed our customer's expectations. With our state-of-the-art technologies along with our highly-experienced team members, Hoosier Pattern continues to deliver the industry's best additive manufacturing molds and cores on time and every time.

WE EXCEED EXPECTATIONS

- » On Time Delivery
- » Quality Products
- » Experienced Team



Get the latest information
HoosierPattern.com

See our virtual tour
HoosierPattern.com/tour

Call Us Today at 260.724.9430





LINE2LINE COATINGS
ABRADABLE POWDER COATINGS

- Race, restoration, development coatings
- Minimizes clearance, lowers friction
- Restores worn parts, protects components
- Pistons—fine tunes fit, reduces rock, rings seal better
- Oil pumps—seals leak paths, improves low rpm pressure
- Turbos and superchargers—increases efficiency, reduces lag
- Bearings—thin coating for protection, thick coating for build-up

Contact: 248-625-3052
line2linecoatings.com



LUCAS OIL PRODUCTS
SLICK MIST CERAMIC SPEED WAX

- Super glossy appearance
- Beading and protection
- Long lasting, instant results
- UV resistant
- Easy to use
- Completely cures in hours
- Overspray will not harm rubber and plastic trim
- Safe on PPF, vinyl wraps, matte finishes, ceramic coated surfaces, gel coat, glass, and chromed surfaces
- Compatible with Lucas Slick Mist Speed Wax

Contact: 317-927-8507
lucasoil.com



MAREDUCCI MOTORSPORTS CLOTHING
POLO SHIRT

- Custom clothing for teams and merchandising

Contact: +52 331 021 6351
maredutti.us

MANDREL BENDS



MERGE COLLECTORS



HEADERS



CUSTOM FAB



CNC MACHINED FLANGES

VIEW OUR CATALOG ONLINE



www.spdexhaust.com
888-778-3312
5393-000
SHEET 1 OF 1
TAB MFG1
14.86+05
-00
D Coyote 5.0L V8
Mustang GT & F150 / 2012 BOSS Mustang
Offering CNC machined flanges for popular OEM and Aftermarket cylinder heads.

Race Engines
From 600cc - 1015cid

- Domestic • Late Model
- Import • Vintage

3/8" & 1/2" Thick Stainless, Carbon Steel & Titanium



888.778.3312

www.spdexhaust.com

Exhaust Engineering Excellence Since 1969



MB QUART 6.5 INCH Q SERIES 2-WAY COMPONENT SPEAKER SYSTEM

- German-built 6.5-inch mobile audio speakers
- 1-inch military A-spec titanium dome
- 6.5-inch lightweight mica-filled poly blend midrange cone for strength and performance
- Q Control crossover network guides the frequencies from the amplifier to each speaker driver

Contact: 847-540-7700
mbquart.com



MILLENNIUM TECHNOLOGIES ISOTROPIC MICRO POLISHING

- Benefits of isotropic micro polishing include: reduced surface stress; reduced friction, vibration and noise; longer component life; reduction in lubrication temperature; increased heat transfer; and mirror-like finish

Contact: 920-893-5595
mt-llc.com



MOLECULE COMP MUD REPEL AND WASH+SHINE KIT

- Bundled kit of new Mud Repel and Wash+Shine products
- Mud Repel—pretreat spray that prevents mud, dirt, and other grime from sticking to vehicle
- Wash+Shine - Post-event spotless wash designed for bucket wash or foam gun

Contact: 949-429-6706
moleculesports.com

SCOTT

PERFORMANCE WIRE™

HIGH PERFORMANCE IGNITION WIRES AND ACCESSORIES

PROPRIETARY DESIGN
PRECISION MANUFACTURED
INDIVIDUALLY TESTED
SOURCED AND PRODUCED IN THE *U.S.A*
UNMATCHED SERVICE

- RACING
- HOT ROD
- STREET PERFORMANCE
- OFF ROAD
- MARINE
- MOTORCYCLE
- ACCESSORIES

AND MORE



WHEN IT MATTERS, YOU BETTER BE RUNNING WITH



PRI BOOTH 2211

TO LEARN MORE, VISIT US AT: SCOTTPERFORMANCE.COM



**MONIT MOTORSPORT
BRAKE BIAS ADJUSTER**

- The next gen remote brake bias adjuster
- Built-in LCD display clearly shows bias position at all times
- Drivers can adjust brake balance while driving and easily see how far they have adjusted
- Works with all balance bars and pedal boxes
- Water and dust resistant
- Battery powered by a user replaceable CR2032 coin cell
- 18-month battery life

Contact: +64 27 359 4814
monitmotorsport.com



**MOTORHEAD DIGITAL
MARKETING MAXIMIZER
PROGRAM**

- Website design optimization
- Digital footprint optimization
- Rank higher in search and get found online
- Social media management
- Content development
- Email marketing
- Stay top-of-mind in your market
- Increase parts and services sales

Contact: 585-766-9785
motorheaddigital.com



**MYRACEPASS
MYRACEPASS DIGITAL
AD NETWORK**

- MRP Digital Ads places industry-focused products or services in front of 100,000+ grassroots race teams and millions of fans
- Partner messaging is distributed across our Network comprising hundreds of race track, series, and sanction websites as well as thousands of racer profiles, news pages, schedule and results pages, and more

Contact: 402-817-4367
myracepass.com

**RACE PROVEN FOR
PEACE OF MIND**



**ENGINE OIL TANKS
FOR ANY APPLICATION**

The last thing you need to worry about is whether your oil reservoir is up to the task. Winners know the benefits of sticking with the industry leader provides peace of mind. The unique internal baffling creates exceptional deaeration of scavenged oil while maintaining a tall column of oil over the pickup ensuring that your engine never misses a beat. Now focus on winning.

1.800.926.7867
petersonfluidsys.com



OIL PUMPS PRIMERS ACCESSORIES

By **Specialty Products Company**

©2022 Niwot Corp. dba Specialty Products Co.®





NEO SYNTHETIC OIL CO. 75W90 RHD SYNTHETIC GEAR OIL

- Developed for use in trans axles, differentials, front and rear wheel
- Designed for high load and high speed
- Superior additives for heat and wear protection
- Used for racing applications like NASCAR, Prototype, IndyCar, road race and out drives

Contact: 562-595-7208
neosyntheticoil.com



PERFORMANCE PLUS GLOBAL LOGISTICS LOGISTIC SOLUTIONS

- The "official" logistics partner of the performance industry
- Our mission is to exceed customer expectations by providing "Best in Class" custom solutions for customer products and value-added services with a personal touch
- We provide each customer with a dedicated professional with experience in performance and transportation to manage their logistics needs with the highest-quality service at unbelievably competitive prices

Contact: 636-946-7587
pplglobal.com



POWER AUTOMEDIA NINE EXPERTLY CURATED AUTOMOTIVE MAGAZINES

- Chevy Hardcore
- Diesel Army
- Dragzine
- Engine Labs
- Ford Muscle
- LSX Magazine
- Off Road Xtreme
- Street Muscle Magazine
- NEW—Electrified, the magazine

Contact: 951-677-2626
powerautomedia.com

COME SEE US IN BOOTH #8626

A6X DROP-N-LOAD THE ONLY AIRBAGGED CARHAULER



MAXX-D TRAILERS





**PRO-TINT, INC.
RACING WINDSHIELD
TEAR-OFFS**

- Multi-layer windshield defense that is pre-formed, pre-cut film
- Cut to the exact shape and size of your windshield
- Whether you're racing a Late Model, Porsche, or Ferrari, we've got what you need to be protected on the track

Contact: 704-918-4520
protintshop.com



**R&M RACE TRAILERS
34-FOOT RACE TRAILER
WITH BATHROOM SHOWER
PACKAGE**

- Custom designed 12-foot-high trailer with upgraded bathroom
- Features electric awning, front tongue box, airline package, built-in tool box, all 12-volt LED lighting, hydraulic tongue jack, aluminum walls with carpeting, rubber coin floor, stereo, 15,000 BTU air conditioning system and more

Contact: 918-225-7223
rmtrailer.com



**RACE ENGINE TECHNOLOGY
RACE ENGINE TECHNOLOGY
MAGAZINE**

- In-depth research and insight on the latest race engine projects
- Comprehensive coverage of all new developments
- Revealing interviews with those central to the ongoing evolution of technology

Contact: +44 1934 713957
highpowermedia.com

**SLIM-FIT
RADIATOR SYSTEMS**

HERE'S THE SKINNY:
RADIATOR + SHROUD + FAN = 4 INCHES THICK!



Inside Third Tank
Allows coolant to flow through the entire radiator nearly eliminating dead space.

Revolutionary Slim-Fit Core
Patented design, allows the fan and motor to be installed inside the core to billet mounting plate.



PROFORMPARTS.COM/SLIM-FIT





RACE FACE BRAND DEVELOPMENT RACE FACE DIGITAL COLLECTABLE CARDS

- Race Face Digital (RFD) is the place to go to collect, buy, and sell digital racing cards representing the next generation of superstar drivers

Contact: 727-247-5597

racefacebranddevelopment.com



RACECHICK LLC RACECHICK FIERCE WOMEN'S RACE SUIT

- Our SFI-rated women's racing suits were designed and developed for the female form
- Combines movement and performance into a great value race suit built to the highest quality standards
- SFI 3.2A/1 and SFI 3.2A/5
- Sizes XS-XL
- Two color options
- One-piece or jacket/pants
- Coordinates with FIERCE racing separates, shoes and gloves

Contact: 800-853-4890

racechick.com



RACELOGIC USA VBOX VIDEO HD2

- Achieve better lap times and greater consistency at the wheel with the ultimate video data logger
- Dual wide-angle 1080 p cameras
- Features live stream capability and real-time graphic overlays
- Log up to 80 CAN channels and GNSS data

Contact: 248-994-9050

racelogicusa.com

UNRIVALED PERFORMANCE

SPAL ELECTRIC COOLING FANS



Crafted by professionals for professionals, SPAL high performance, electric cooling fans (brushed and brushless) provide maximum reliability, extreme durability and superior performance under the most challenging race conditions that is second to none.



SPAL AUTOMOTIVE USA

PHONE: (800) 345-0327

EMAIL: INFO@SPALUSA.COM

WEB: WWW.SPALUSA.COM



**RACING ELECTRONICS
RECEIVER PRO**

- The most advanced micro-receiver available for competitors
- 3.5mm (1/8") stereo or mono audio in/out ports
- Two programmable RF channels
- 450-470 MHz range
- 12.5 KHz bandwidth
- 1600 UHF channel bank
- LCD Display (1.44" x .88")

Contact: 800-272-7111
racingelectronics.com



**REDLINE ACE
REDLINE ACE DESIGN
SERVICES**

- In an industry where wins come by razor-thin margins, why not invest in agency-level design as a true under-the-radar advantage to upgrade your brand before your competition does?
- Logos/branding
- Livery design
- Marketing materials
- Team assets
- Any level driver, team, and series

Contact: 317-760-4903
redlineace.com



**REDTIDE CANOPIES
CUSTOM ENCLOSURE KIT**

- Our enclosure kits are perfect for racers and vendors looking to secure their area and promote their brand day and night
- Available in 10 feet x10 feet, 10 feet x 15 feet, 10 feet x 20 feet, and 13 feet x 26 feet

Contact: 801-644-3161
whatisredtide.com

THE LEADER ...IN AQUEOUS PARTS CLEANING

The ArmaKleen Company
safety-kleen®

Professional Racers Turn to ArmaKleen

ARMAKLEEN™ supplies only the highest quality environmentally sensible aqueous parts cleaning formulas and paint removing chemicals. Our innovative, patented cleaners are rigorously tested and designed for use in almost all commercial and industrial parts cleaning applications

ArmaKleen.com & ArmaKleen.com/Ask-Andy

Logos for NASCAR, Monster Jam, and Monster SuperCross are also present.



**REM SURFACE ENGINEERING
REM ISF RACE SURFACE
FINISHING LINE**

- Reduces friction
- Increases durability
- Extends lubricant life
- The performance advantages of the ISF Process over other Superfinishing techniques are because it creates not only an asperity-free surface, but also imparts a unique texture to the surface of the component that facilitates lubricant retention

Contact: 860-621-6755
remchem.com



**SAFETY SYSTEMS INC. -
FIREBOTTLE
AMRC-501**

- New sprint dirt car system
- SFI 17.3
- 10 lbs. total weight
- Comes with roll bar mounts and everything needed for installation

Contact: 239-995-6300
firebottleracing.com



**SCHOOL OF AUTOMOTIVE
MACHINISTS & TECHNOLOGY
SAM TECH**

- Training winning engine builders since 1985
- Curriculum includes block, head, and CNC machining
- EFI Calibration Program also available
- Learn what it takes to be a part of a championship-caliber professional race team with hands-on experience

Contact: 713-683-3817
samtech.edu

PYROTECT SAFETY PRODUCTS

NEW PRODUCTS 2022

					<p>SCAN ME WITH PHONE</p> <p>©PYROTECT SAFETY, INC. 2022</p>



SHIRT WORKS RACEWEAR
2023 SHIRT WORKS
PROMO SHIRT

- Here it is, the 2023 Shirt Works Promo Shirt
- Free with all new orders

Contact: 989-448-8889
shirtworksracewear.com



SHOCKER HITCH LLC
SHOCKER HD 20K AIR
HITCH WITH COMBO BALL
MOUNT

- Smoother, safer towing
- Adds instant air-ride with the built-in airbag that absorbs the bumps, bangs, and jerks—cushioning the ride for both your tow vehicle and trailer
- 11+ ball mount options to choose from
- 20,000-lb. towing capacity
- Available in safety red or matte black finish

Contact: 701-707-2666
shockerhitch.com



SOUTHERN ADRENALINE
CUSTOM FIT RACE
RECEIVERS

- Plug directly into your Raceceiver to help you isolate the radio traffic coming from the tower officials into your ears at a reduced volume level
- 2-Hz frequency response
- 16 KHz/-4dB
- 115 dB SPL maximum output
- Weighs less than one ounce plus ear molds
- Standard 3.5-mm mono jack plug

Contact: 817-371-2350
southernadrenaline.net

CATCH US AT PRI
BOOTH # 8421

GET LIFTED!



Hydraulic Bumper Pull TJ

This unit is available for bumper pull & towable trailers and uses the same 3 bolt triangle hole pattern as manual or electric jacks for easy installation.

EQ

SYSTEMS

800-846-9659

WWW.EQSYSTEMS.US

19300 GRANGE STREET

CASSOPOLIS, MI 49031

- 16" stroke cylinder
- Commercial single function pump with manual override screw drive
- Simple rocker style switch control
- 6,000 lbs. lifting capacity
- Built-in key for safe lockout of the jack
- Steel pump cover

GET CONNECTED

NEED SOMETHING CUSTOM? WE CAN DO THAT!

Custom Wire Harness & Battery Cable Solutions

WE HAVE OVER 20 YEARS OF EXPERIENCE IN WIRE HARNESS BUSINESS



EQ

HARNESS

EQHARNES.US

800-846-9659





SOUTHERN DRAG BOAT ASSOCIATION DRAG BOAT RACING ASSOCIATION

- Fastest show on water
- Drag racing on water with speeds in excess of 260 mph
- Partnered with Trinity Racing Ministries, the SDBA is currently the only association running Top Fuel
- We race from personal watercraft up to Top Fuel Hydro with many classes in-between

Contact: 830-385-3106
sdbaracing.com



SRI - STOCK CAR STEEL DRAWN OVER MANDREL (DOM) COLD DRAWN STEEL TUBING

- Stock Car Steel and Aluminum offers a wide variety of raw materials, from aluminum to steel to plastics
- DOM tubing is commonly used in the manufacturing of race cars and motorcycle frames
- Stock Car Steel stocks multiple options of various diameter and thickness sizes and custom cuts

Contact: 704-664-3044
stockcarsteel.com



STAUBLI CORP SPH/BA CLEAN-BREAK COUPLINGS FOR MOTORSPORTS

- Shock absorber, brake and hydraulic lines
- Bayonet locking system ensures resistance to high vibration
- Secure and easy connection: just push and twist
- Flush-face design ensures no air enters the system during connecting and no leakage when disconnecting
- Eliminates the need to purge the system
- Permits use of pre-filled hoses

Contact: 864-433-1980
staubli.com

1997

The primary objective of QualCast was and is to provide the engine Parts Aftermarket with THE BEST QUALITY PRODUCTS AVAILABLE IN THE WORLD

Black Lightning Diesel Performance Kits

Celebrating



Years

2022

HEAVY DUTY LIGHT DUTY QUALFAST

QualCast Heavy Duty Valve Train Kits



www.QualCast.com
888-432-4552





**STROUD SAFETY INC.
SFI 20 BOOT**

- Brand new design
- Slip, shock and heat-resistant soles
- Kevlar stitching from the sole to the boot
- Leather in high wear areas
- Velcro calf
- Adjustable ankle strap
- SFI 20
- Men's sizes are 4-14
- Packaged in travel drawstring bag

Contact: 405-632-2022
stroudsafety.com



**SUNSHINE METALS
ALUMINUM BAR, PLATE,
AND HAND FORGING**

- Aluminum plate, bar, and hand forging cut to your exact size or machined to near net shapes up to finished products

Contact: 316-218-5168
sunshinemetals.com



**SURGE INDUSTRIAL
MULTI-PURPOSE TOWELS**

- Industrial strength cleaning and degreasing
- Tough, dual-sided towels with abrasive side for scrubbing
- Non-smearing and non-transferring of dirt and grease on surfaces (dirt adheres to towel)

Contact: 330-995-4000
surgeindustrial.com



wcfab.com
Booth #4047

**Diesel Performance
UTV/Side X Side
Powder & Ceramic Coating
Fabrication & Machining**



630-277-8239 - DeKalb, IL





T&E ENTERPRISES AUTO HAULERS T&E AUTO HAULERS ALL ALUMINUM RACE TRAILERS

- Custom built by racers, for racers
- Designed for Sportsman and Pro classes
- Tag, gooseneck/fifth, stacker, sprint car, semi, vending, and coach models
- Personalized support and customer service

Contact: 815-426-2761
tande-racetrailers.com



TELFER DESIGN 2021 ROLEX REUNION LAGUNA SECA

- The official painting used for the Rolex Monterey Motorsport Reunion in 2021
- The art was featured on billboards, event tickets, programs, and advertising

Contact: 408-813-7553
kellytelfer.com



THERMO-TEC ADHESIVE-BACKED HEAT BARRIER

- The Adhesive Backed Heat Barrier protects parts and components from radiant heat
- It can be used in applications to protect painted surfaces, plastic parts or any component from the damaging effects of radiant heat
- Adhesive Backed Heat Barrier is made up of woven silica with a flexible aluminized finish

Contact: 419-962-4556
thermotec.com

Header Components

Merge Collectors



Mandrel Bends

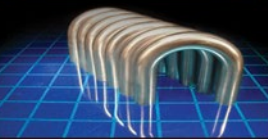

Header Flanges



Race Mufflers



Complete Header Build Kits



High Performance Oval Exhaust



We are your #1 source
for high performance USA
made header components
in mild, 304, 321 and
aluminum materials.

Stainless Headers
MFG. INC.
PERFORMANCE ENGINEERED COMPONENTS

1-800-290-3920 1-651-448-8661

www.stainlessheaders.com

GANDRUD

PERFORMANCE PARTS

CHEVROLET PERFORMANCE
VEHICLES / PARTS / RACING

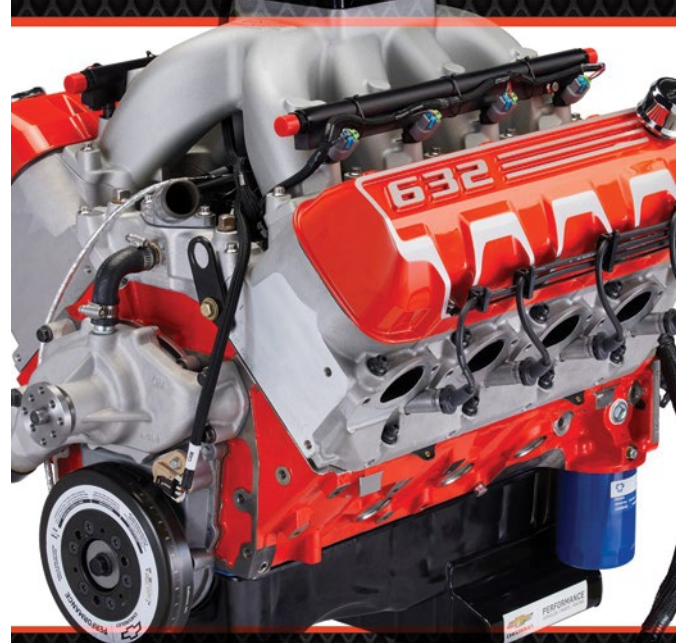

www.gmperformancemotor.com



TORCO INTERNATIONAL CORP.
TORCO SR-1R SYNTHETIC RACING OIL

- Premium 100% synthetic racing oil with a selective blend of premium Group III, Group IV, and Group V base oils combined with our proprietary MPZPlus system to increase power, efficiency, and engine protection
- Available in 10W-30, 10W-40, 10W-60, 20W-50, and 25W-60
- mPAO base and friction-reducing moly increase horsepower and torque
- Shear-stable polymers resist viscosity thinning under severe conditions

Contact: 909-980-1495
torcousa.com



TOTALENERGIES
TOTALENERGIES QUARTZ INEO RACING 10W60

- Quartz Ineo Racing 10W60 synthetic engine oil is formulated for extreme conditions
- Benefits include anti-wear protection, performance, and oil film resistance

Contact: 832-207-5529
services.us.totalenergies.com



TRAILER ALARMS LLC
CUSTOM SECURITY SOLUTIONS

- Let us help you find a security solution for your needs and that fits your requirements
- We offer "Security in an Instant" without PTS-2 products

Contact: 877-604-7381
trailer-alarms.com

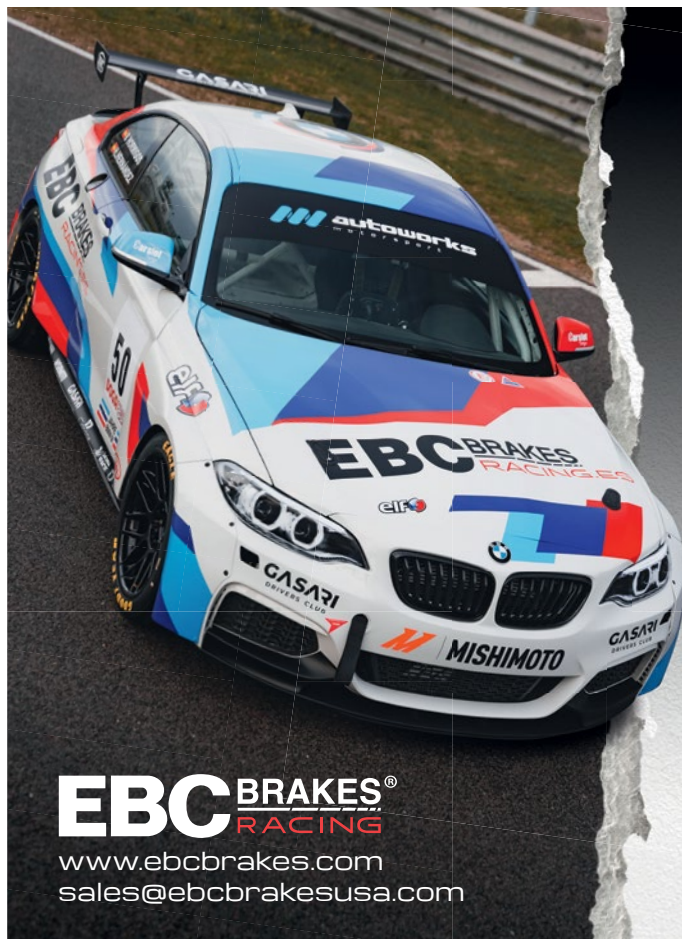

EBC BRAKES®
RACING
www.ebcbrakes.com
sales@ebcbrakesusa.com

UNPARALLELED
BRAKING
PERFORMANCE

EBC Brakes Racing's range of motorsport products sets a new high-water mark in the world of track day and race braking.





TRENCHANT TECHNOLOGIES LTD. LIFECHECK—COMPONENT LIFING SOFTWARE

- Component Lifting is vital for managing performance, improving safety and controlling costs, within professional motorsport
- LifeCheck effortlessly tracks millions of parts, optimizing life critical inventory, for over 75 professional motorsport teams, across multiple chassis and locations, in F1, IndyCar, NASCAR, and other race series

Contact: +44 1724 897318
trenchant-tech.com



TRENSOR/3FP PERFORMANCE RACING SENSORS

- 3FP sensors are Trensor's ultra-premium pressure sensors for the harshest automotive environments
- Developed with Trensor's industry-leading technology and manufactured for accuracy and dependability
- These sensors are widely used across the performance, racing, off-road, marine, and specialty vehicle markets

Contact: 949-379-6730
trensor.com



TRIBODYN LUBRICANTS TRI-EX2 MOTOR AND GEAR OIL

- Tested #1 for extreme pressure and film strength
- Reduces operating temperature
- Performs under extreme heat and pressure
- Enhances motor performance and hp
- Forms a ceramic coating under extreme conditions
- Reduces wear and increases engine life
- Improves carbon footprint and fuel mileage
- Patented ceramic lubricants

Contact: 704-266-3577
tribodyn.com

WOOLF AIRCRAFT

Specializing in Tube Fabrication:
Bending and Welding Since 1942



PRI SHOW
BOOTH 5167

734-721-5330 WOOLF AIRCRAFT.COM

SCS GEARBOX



SCSGEARBOX.COM | PROBELLRACING.COM

Visit Us at the 2022 PRI Trade Show
to Learn About SCS Gearbox &
Probell Racing Products



Booth # 4206

Like us!



419-483-7278 | 567-214-8182



**TRIVINCI SYSTEMS LLC
ROAD-KEEPER HD**

- The Road-Keeper HD video and data logger is our latest innovation, developed using our experience in the video and data logging arena in motorsports, driving experiences, and beyond
- It brings dual stream HD video combined with high-quality GPS data within reach of everyone at the track or on the road

Contact: 703-843-4235
race-keeper.com



**TURNKEY INDUSTRIES
RACE TRANSPORTER**

- Custom race trailers and stackers built to your specifications
- All aluminum, fastener-free exterior sheets for a smooth appearance
- Lightweight
- Aluminum cabinets and lift gates

Contact: 281-753-5951
tkind.com



**ULTIMATE AWNING
AWNING AND CANOPY
SHELTER SYSTEM**

- Patented on-demand connection technology shelter systems
- Cam-Loc integrated billet quick connects no cables to pull
- Cam-Loc quick connect adjustable legs
- Ulti-Loc integrated billet frame connectors no quick pins, no latches, and no Velcro
- Side-exit Ulti-Gutters—no rain drain tubes

Contact: 612-816-9644
ultimateawning.com



**HOT SHOT'S
SECRET**
POWERED BY SCIENCE

**#1 FASTEST
GROWING**

PERFORMANCE LUBRICANT BRAND IN THE U.S.A.

JOIN OUR DEALER NETWORK



VISIT US AT PRI SHOW BOOTH# 4005

HotShotSecret.com 800.341.6516    

AVAILABLE AT 



VALCO CINCINNATI CONSUMER GELLUBE

- Aerosol assembly lubricant
- Sprays on as a liquid and converts to a load bearing gel within seconds
- Blends with motor oil
- Good for valve springs, cylinders, timing chains, wrist pins, gear boxes, nuts and bolts, oil pumps, cams, lifters, rocker arms, bearings, pistons, sliding parts, and much more

Contact: 513-874-6550
valco-cp.com



VELOCITA DRIVING SUITS CUSTOM DRIVING SUITS

- Custom driving suits
- One-piece fire suits
- Two-piece fire suits
- Racing gloves
- Shoes
- Karting suits
- Crew shirts
- Gear bags

Contact: 336-764-8502
velocita-usa.com



WAGNER RACE PRODUCTS SBR1

- High-end custom-built race simulators
- Turn-key chassis built around your focused racing program
- Delivery, setup, training, and coaching available
- The most adjustable platform on the market
- Simulator comes complete with all software loaded and tested
- Built to last, we have simulators that are still in use today that were built and delivered in 2005

Contact: 952-368-6088
wagnerraceproducts.com

DRY SUMP OIL PUMPS

Since 1966



Dry and wet sump oil pumps to fit most applications. Mounts and configurations for...

- LS/GM Engines
- Dirt Late Model
- Drift Racing
- Off-Shore racing
- Sprint Car & Midgets
- Stock Car racing
- Drag Racing
- Off-Road racing

Custom mounts and pump configurations available.

barnessystems.com

(310) 534-3844 ph

Made in the USA.

sūsa
SetrabUSA.com

oiling system components
for racing cars



Setrab
Oil Coolers

the choice of top teams and builders
across all venues of motorsport



**WEIGH-SAFE
WEIGH SAFE HITCH**

- The revolutionary and SEMA award-winning Weigh Safe hitch is an aluminum adjustable ball mount that has a built-in scale to measure tongue weight
- This hitch will take the “guesswork” out of towing safely and properly
- Includes two stainless steel tow balls
- Dual-pin lock
- A variety of drop and shank sizes
- Industry-leading weight ratings

Contact: 801-820-7020
weigh-safe.com



**ZAMP INC.
RZ-880 AND RZ-88C SUPER
SERIES HELMETS**

- Meets FIA 8860-2018 safety standard
- Advanced carbon weave for an incredibly lightweight shell
- RZ-880: Open wheel matte carbon version with maximum venting
- RZ-88C: Closed cockpit gloss carbon version designed for dirt racing
- Easy communications installation with EPS channels in helmet
- Includes clear anti-fog Z-24 shield

Contact: 208-506-3030
zamp-racing.com



**ZYCOAT
ZYBAR HIGH TEMPERATURE,
HEAT DISSIPATION COATING**

- Revolutionary new high temperature, heat dissipation coating for headers, turbos, manifolds, exhaust, and more
- Rated to 2100° F ambient and 1600° F metal surface temperatures
- Outperforms ceramic paints in durability, corrosion resistance, and high temperature

Contact: 913-599-2600
zycoat.com

2x4

EFI SYSTEM

Classic pro street looks
with modern driveability

Advanced self-learning technology for a smooth idle and performance
New robust ECU with remote relay box and wiring harness
Multi-bolt pattern fits most tunnel rams or cross ram intakes
Naturally aspirated supports 625 HP, boosted engines up to 1,200 HP
Power adder system supports up to 21.7 lbs of boost

<p>GO EFI 2x4 Systems 625 HP, Bright Aluminum, PN 30061 625 HP, Matte Black, PN 30062</p>	<p>2x4 Power Adder Systems 1,200 HP, Bright Aluminum, PN 30065 1,200 HP, Matte Black, PN 30064</p>
--	---

951-340-2624

sales@fitechefi.com

FiTechEFI.com



SECTION

4

MACHINERY, TOOLS & EQUIPMENT

Discover the latest machining and shop equipment designed to enhance cutting, honing, porting, surfacing, grinding, testing, cleaning, or nearly any other process or operation, along with cutting-edge fabrication and welding solutions engineered to help accelerate workflow and boost output, as well as several new-to-market tools and tooling products for engine builders, car builders, machinists, and more.

COMEC, INC.

comecus.com | 800-887-6076



ACF200CNC CNC BORING MILL

- Simple conversational operation
- Dual panel touchscreen control
- Ballscrew drives, linear slideways, and brushless servomotors
- Boring, milling, and fixturing included
- 2.5-inch – 6.7-inch diameter
- CBN/PCD milling head

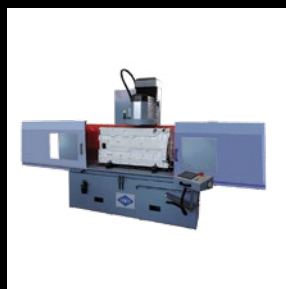

RP140CNC CNC HEAD AND BLOCK SURFACING MACHINE

- Simple conversational operation
- Dual panel touchscreen control
- 16-inch CBN/PCD milling head
- Cutter and column height stored in memory
- Laser surface scanning
- Automatic and manual control modes
- Capacity for large diesel heads and blocks



LEV300 CYLINDER HONING MACHINE

- Programmable vertical stroke cylinder honing machine
- Simple touchscreen operator control
- Adjustable crosshatch angle
- Friction feed hone head/uses standard Sunnen AN-type stones
- Software adjustable upper and lower overstroke
- User definable dwell parameters
- Universal block mounting fixture, holds up to 35 inches long V and inline blocks



RV516ASM CENTERLESS VALVE REFACER

- Centerless chuck design
- Infinitely variable workhead rpm
- 4-mm – 5/8-inch valve stem diameter capacity
- 0–60 degree angle, up to 4-plus-inch head diameter capacity
- Wheel dresser and micrometer butt grinder included
- Work stand included

PRI MEMBER BENEFITS

10%
PREVAILING RATES
(EXCLUDES BLACKOUT DATES)



HYATT
REGENCY
INDIANAPOLIS

JOIN TODAY!

VISIT:
PERFORMANCERACING.COM/MEMBERSHIP



COMPUTECH



RACING WEATHER STATION

- Temperature
- Humidity
- Pressure
- Performance Altitude
- Humidity Grains
- Air Density Ratio
- Correction Factor
- Wind Speed & Direction
- Sunlight Intensity
- Text Messaging
- Improved Paging
- New Software
- Easy Installation
- 24/7 Tech Support

Computech.com 301.884.5712

ROBINS - *Significant* + Exactly

VR10P

Extreme-Precision Valve Grinding Machines...

VR5



VR5 VALVE GRINDING MACHINE

VR10P



• Large coolant & filtration.
Cool & Clean grinding

Anthony DiBer (941) 800-7126
Eastern USA & Canada

ROBINS
CORPORATION
RobinsValves.com

Jeff Marchion (909) 238-9922
Western USA

PRI MEMBER BENEFITS

15%

OFF ANY JMS CHIP AND
PERFORMANCE PRODUCT**JMS**
JMSCHIP.COM**JOIN TODAY!**VISIT:
PERFORMANCERACING.COM/MEMBERSHIP

PRI MEMBER BENEFITS

10%

OFF WEBSITE
PRICING**JOIN TODAY!**VISIT:
PERFORMANCERACING.COM/MEMBERSHIP**GIANT FINISHING**

giantfinishing.com | 708-343-6900

GIANT
FINISHING, INC.**GIANT MODEL W-5**

- Five cu. ft. vibratory tub
- 19-inch x 35-inch process chamber
- Standard 1-1/2 hp motor with 110 V 1 PH variable frequency drive
- Steel hinged sound enclosure
- 10-gallon fabricated settling tank
- Casters for portability
- Media discharge chute

**GIANT MODEL GB-3**

- Three cu. ft. vibratory bowl with internal separation
- 9-inch process channel
- Standard 1-1/2 hp motor with 110 V 1 PH variable frequency drive
- Interchangeable screen deck

**GIANT SLURRY BLASTER**

- 48-inch x 36-inch process chamber
- 12-gauge stainless steel construction
- Laser-cut and hand-welded dual-access double-panel doors
- Window wiper with control knob
- Fresh water rinse hose
- Ergonomic blast gun
- Heavy-duty slurry pump
- Air regulator
- Foot pedal operation
- 20-watt LED lighting

**GIANT GCB CENTRIFUGAL BARREL FINISHER**

- Minimal process times
- Variable frequency controls
- Variety of barrel option configurations to choose from
- Safe and easy operation

MAGIDO USA INC.

magidousa.com | 844-462-4436



X-81 PARTS WASHERS

- Jet-spray cleaning from top, bottom, and side angles
- Rotary turntable: 23 inches and 30 inches
- Working height: 19.5 inches
- 304 stainless steel construction
- Minimal floor space requirements
- Save you time and money



X-51 TOP-LOAD PARTS WASHERS

- Delivers fast and efficient cleaning results
- Jet-spray cleaning from top, bottom, and side angles
- Double the cleaning action with two pumps and spray manifolds
- Rotary turntable: 35 inches – 51 inches
- Working height: 19.5 inches – 27.5 inches
- 304 stainless steel construction
- Larger working space
- Rinse and drying options available



HP GLOVEBOX PARTS WASHERS

- Powerful 870 PSI jet-spray wand
- Viewing window with LED light
- 304 stainless steel construction
- Large working area
- Deliver high-performance cleaning action



X-53 FRONT-LOAD PARTS WASHERS

- Jet-spray cleaning from top, bottom, and side angles
- Rollout turntable with cart 43 inches – 72 inches
- Working height: 30.5 inches – 39.5 inches + more
- 304 stainless steel construction
- Maximum working space
- Rinse and drying options available
- Engineered to solve your toughest cleaning challenges

PRI MEMBER BENEFITS

\$15

OFF ALL-ACCESS MEMBERSHIP



JOIN TODAY!

VISIT:
PERFORMANCERACING.COM/MEMBERSHIP

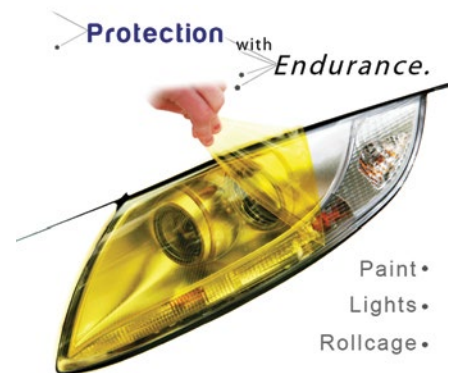

LAMIN-X
PROTECTIVE FILMS

lamin-x.com

CECOMP® F20B Series 8 Memory Pressure Gauges



Tires – Shocks – Compression – Vacuum
cecomp.com 800-942-0315

PRI MEMBER BENEFITS

10%

ANY 2 OR 5 DAY
WELDING WORKSHOP

JOIN TODAY!

VISIT:
PERFORMANCERACING.COM/MEMBERSHIP

PRI MEMBER BENEFITS

10%
DISCOUNT

JOIN TODAY!

VISIT:
PERFORMANCERACING.COM/MEMBERSHIP

SERDI CORPORATION

serdimachines.com | 800-447-3790



PROFILE

- CNC cylinder head machining center
- New lighter spindle with dynamic balancing and Triple Airfloat
- Industry best concentricity and accuracy
- Siemens Industrial CNC control
- Simple conversational seat geometry design and editing
- 1.2-inch – 4.7-inch seat diameter capacity
- Vertical gantry design increases rigidity and work envelope



S4.5 LONG BEAM

- Cylinder head seat and guide machine
- Large base/extended beam accommodates largest and smallest heads
- Machine head moves from work envelope for loading and unloading
- Triple Airfloat—best centering sensitivity and accuracy
- 3 hp spindle motor
- Airfloat head fixture table for Y-axis movement of work
- Includes built-in vacuum tester



S3.5

- Cylinder head seat and guide machine
- Small base machine perfect for automotive, small engine, and medium diesel work
- Triple Airfloat—best centering sensitivity and accuracy
- Airfloat head fixture table for Y-axis movement of work
- Includes built-in vacuum tester, tool sharpener and tool storage rack available

SUNNEN PRODUCTS COMPANY

sunnen.com | 314-781-2100



SV-35 CYLINDER HONE

- Next generation of the legendary Sunnen Cylinder King line
- Constant crosshatch from top to bottom of the bore for optimum ring sealing
- New Sunnen2 system controls for simple setup and operation
- Automatic, unattended bore-to-bore honing



SV-15 CYLINDER HONE

- Large touchscreen with easy-to-use controls
- Fast, easy setup
- Up to 100 setups can be saved with USB backup
- Bore profile display allows honing to end specs without stopping to gage bores



SH-4000 CON ROD HONE

- Automatically hones connecting rods to size
- Easy to set up and operate with minimal operator training
- Rods are honed square with the face, round and straight
- Can also be used for piston pin bores, small ending cylinders and other parts



CH-100 LINE HONE

- CH-100 is the industry standard for align honing of main bearing bores
- Fast, easy setup
- Brings main bores back to perfect alignment with minimal stock removal
- Hones a wide variety of blocks: inline, V6, V8, and diesels

PRI MEMBER BENEFITS

\$10
OFF \$100
PURCHASE



JOIN TODAY!

VISIT:
PERFORMANCERACING.COM/MEMBERSHIP



PRI MEMBER BENEFITS

10%

DISCOUNT TO ALL
PRI MEMBERS
THROUGH WEBSITE
(www.SPPEdiagnostix.com)

SPEEDiagnostix
How To Know You're Good To Go.

JOIN TODAY!

VISIT:
PERFORMANCERACING.COM/MEMBERSHIP





HOWARDS
cams
& RACING COMPONENTS

MORE than Camshafts

75 Years of Race Winning Innovation!

920.233.5228 • FAX: 920.233.0938
howardscams.com • info@howardscams.com

WARNING: Cancer and Reproductive Harm
www.P65Warnings.ca.gov



**A1 CYCLES
DRAIN DADDIE**

- Fluid transfer and recycling device
- Prevent spills, save time, and protect the environment

Contact: 561-603-6671

draindaddie.com

ULTRA-HIGH PERFORMANCE PISTONS



MADE
IN THE U.S.A.
SINCE 1979!

Custom and off
the shelf offerings
for most import &
domestic applications.

ROSS
racing pistons

PHONE: 310.536.0100
EMAIL: SALES@ROSSPISTONS.COM
WEB: WWW.ROSSPISTONS.COM



**ABS PRODUCTS
ABS PRODUCTS
PROFESSIONAL 64-INCH
AND 72-INCH HAND HELD
POLISHER**

- High-strength aircraft quality aluminum
- Efficient, lightweight, and extremely versatile
- Quick-release system for belt adjustment
- Bearing rollers will accommodate 3/4-inch – 2-inch belts
- Make polishing your crank, cam, rack and pinion, etc. quick, simple, and cost effective
- Patent pending
- Made in the USA

Contact: 714-671-0728

abs-products.com

DRIVELINE STUDIOS



STRATEGY | CONTENT | SOCIAL MEDIA | GRAPHIC DESIGN

LET'S GET STARTED

DRIVELINESTUDIOS.COM

DAIDO METAL

RACING BEARINGS

REVOLUTIONARY FLOATING FLANGE

Increased Thrust Capacity
 Three Piece Design
 Optimum End Play
 Reduced Oil Leakage
 Precise Grades

RACE PROVEN MATERIALS

Silicon-Aluminum Thrust Washers
 Lead-Indium Overlay
 Copper-Lead Alloy

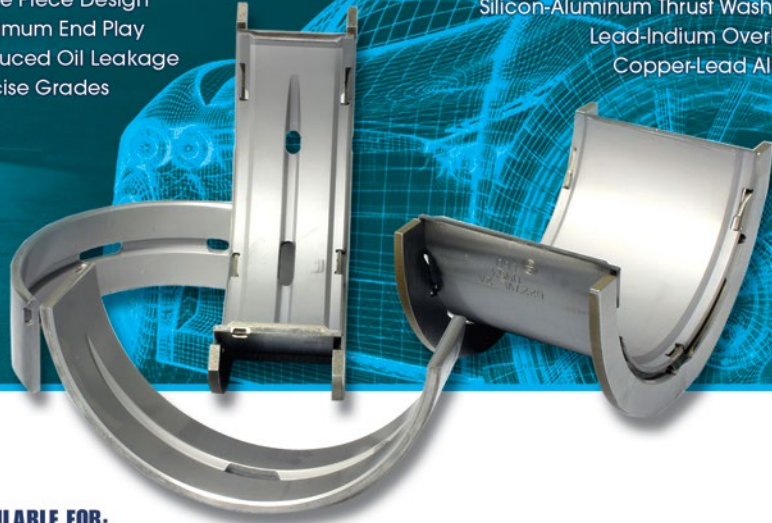

AVAILABLE FOR:

Chevy Small Block • Chevy Big Block
 GM LS1 • 426 Hemi

WWW.CALLIES.COM/DAIDO

SECTION 4

MACHINERY, TOOLS & EQUIPMENT



ACCU-FORCE DYNOS & TESTERS DYNOS, TESTERS, AND CONSULTING

- Spring smashers
- Shock dynos
- Torsion bar dynos
- Chassis consulting

Contact: 330-674-2847

accuforcetesters.com

3" Tube Aluminum Driveshafts
3-1/2" Tube Aluminum Driveshafts
3" Tube Steel Driveshafts
2-1/2" Tube Steel Driveshafts

pro-lite **Lightweight Harmonic Balancers**
 * All Steel
 * All Aluminum
 * Aluminum With Steel Sleeve

pro-lite **Lightweight Quick Change Gears**
 .875 Wide
 Only 2.9 Lbs.

COLEMAN RACING PRODUCTS
colemanracing.com
 N1597 US41
 Menominee, Mi 49858
 Phone: (800) 221-1851
 Email: sales@colemanracing.com

colemanracing.com



ADVANTAGE LIFTS DX-9000-XLT

- Expertly designed to work without wobble or compromise
- Gives you an extra foot underneath the runway, 26-inch longer runways, and an additional 6 inches of drive through clearance compared to the Advantage DX-9000-HD
- Allows taller individuals room to walk underneath, and the ability to put an SUV or truck on top or underneath (up to 6 feet 10 inches tall underneath runway)

Contact: 763-300-5730

advantagelifts.com

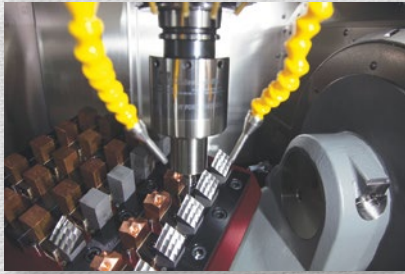

**AIR TURBINE TECHNOLOGY INC.
AIR TURBINE SPINDLES
650 SERIES**

- Retrofit your CNC machine with proven performance and reliability
- Governed constant 25,000–40,000 rpm under load
- Up to 0.88 hp, with Double Turbine 650X version that reaches 1.40 hp
- Only needs 90 psi/6.2 bar air
- Effective in all materials, Including tool steel, titanium, and ceramics
- Mill 24/7

Contact: 561-994-0500
airturbinetools.com

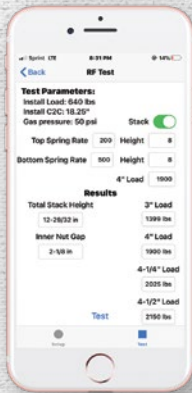

**B4 UNLIMITED
SPRINGRITHM**

- Puts a spring smasher into the palm of your hand
- Set your coil nuts without a spring smasher
- Analyze dynamic loads in seconds
- Set up and analyze stack springs, too

Contact: 504-874-2675
springrithm.com



940A1R83
Speedway/Pro Shocks Sprint
Car A1 Adjustable Shock



91077855
Speedway Chromoly Round
Tube Rear Wing Tree



10680201N
AFCO 80201N, Sprint Double
Pass Radiator



SpeedwayMotors.com/PRImagazine
855.313.9173



BEND-TECH DRAGON A400

- The Dragon A400 CNC plasma tube cutter makes any design with holes and end cuts
- For shops that use tubes and pipes in their process, the Dragon A400 is an essential time-saving tool
- Contact us to schedule a live Zoom demo to see your parts in CAD and production

Contact: 715-294-2000

bend-tech.com

2015-2019 DODGE HEMI SUPERCHARGER SYSTEMS

- ✓ 730 HP @ 7 PSI SAFELY FROM 6.4L SYSTEMS ON 91 OCTANE PUMP GAS
- ✓ NO STALLS, NO STUMBLES... JUST SMOOTH, FACTORY-LIKE DRIVABILITY
- ✓ CARB APPROVED: E.O.# D-213-39,50-STATE EMISSIONS LEGAL SYSTEMS AVAILABLE



30 YEARS OF
LEGENDARY EFFICIENCY,
PERFORMANCE & POWER

SAFE, SMOOTH, AND 100% LEGAL
HORSEPOWER LIKE NO OTHER KIT AVAILABLE!

BOOST YOUR PERFORMANCE TODAY
805.247.0226 | vortechsuperchargers.com
#POWEREDBYVORTECH

VORTECH
SUPERCHARGERS



BLUE DEMON WELDING PRODUCTS GAMECHANGERS WELDING GLOVES

- Blue Demon Gamechangers series of welding gloves—a heat shield and a glove in one
- With our patent-pending design, integrated with proprietary Kagan heat-shield fabric, each pair of Gamechangers welding gloves has the heat protection where your hands need it most
- Available in four styles to meet the needs of all welders

Contact: 888-905-6737

bluedemonwelding.com



**BOLTSANDNUTS.COM
BOLT & NUT
MEASURING GAUGE**

- Inch and metric
- Coarse and fine threading
- Measures fractional bolts from size #4 to 1 inch up to 7 inches long
- Measures metric bolts and screws from size 3 mm to 22 mm
- Made of durable 1/4-inch thick plastic
- 1/4-inch thick x 8-3/4-inch long x 3-3/8-inch wide
- Color: Red

Contact: 440-606-6557
boltsandnuts.com



**CARR LANE MANUFACTURING
HOIST RINGS**

- Top-rated load capacity and an industry leading safety factor of 5:1
- Choose between swivel, side pull and pivoting models
- Available in inch and metric varieties, with load capacities up to 100,000 lbs.
- Offered in many finishes and materials to meet your strength requirements

Contact: 314-647-6200
carrlane.com

MOVING THE PERFORMANCE INDUSTRY COAST-TO-COAST & AROUND THE WORLD

**WE KNOW YOUR PRODUCTS...
WE UNDERSTAND YOUR BUSINESS...**

WE HAVE A SOLUTION!

**LTL FREIGHT & TRUCKLOAD
ENGINES OVERNIGHT
FREIGHT INSURANCE
WAREHOUSE FULFILLMENT**

PRI
DECEMBER 8-10, 2022

EXHIBITOR
BOOTH # 3421



**(866) 966-PLUS • PPLUSGLOBAL.COM
(7587)**

**OFFICIAL LOGISTICS PARTNER
OF THE PERFORMANCE INDUSTRY**

All sets precisely matched using Fuel Injector Clinic's proprietary Data Match Technology, the most complete flow matching and latency value information available in the industry.

**DATA
MATCH
TECHNOLOGY**

Visit Us In Booth 609



1440cc Injector with USCAR Plug

- Compatible with ALL Fuels
- Competitively Priced
- Drop In Fitment
- Great Tuning Data
- Lifetime Warranty
- Bosch Injector
- All Makes. All Models.

FIC
FUEL INJECTOR CLINIC

The leader in high flow rate performance fuel injectors with the latest injector technology for performance engines. Sizes from 365cc to 2150cc—32lb to 200lb. Dealer programs available.

fuelinjectorclinic.com/warranty • 561.427.0082



CCA RACING PRODUCTS CONNECTING ROD VISE

- Made in the USA
- High-quality connecting rod vise built to hold up to daily use in your shop
- Features removable speed wrench, thrust and guide bearings, and a 7-inch wide throat fits most connecting rods
- Part of our line of generational-quality engine assembly tools

Contact: 844-265-9898

ccaracing.com

Every Toolbox Needs...

WALTON™ Tap Extractors & Tap Extensions

Performance professionals have depended on high-quality Walton tools since 1908.

TAP EXTRACTORS

- Remove broken taps simply and safely, without drilling, lasers, damaged threads, scrapped parts or repair inserts.
- Available in every tap size, both inch and metric.

TAP EXTENSIONS

- Extend the reach of regular-length taps and allow tapping in deep holes and awkward locations.
- Square and round sockets conform to leading tap sizes.
- Suitable for both machine and hand-tapping.



Available as sets or individual pieces.

WALTON
COMPANY



Tapping into good ideas
for over 110 years.

(860) 523-5231
sales@waltontools.com

www.WaltonTools.com



CENTROID CNC A560 5-AXIS CNC MACHINING CENTER

- Machine cylinder heads and blocks
- Unique heavy-duty ballscrew drive and articulating 5th axis
- Superior rigidity = best finishes
- Turn-key package
- Expert training
- Outstanding customer service and support

Contact: 814-353-9290

centroidcnc.com



**CTECH MANUFACTURING
HALF ASS SERVICE CART &
CASTER KIT**

- We've reinvented the wheel for the sake of better storage
- Our new HalfAss Caster takes your CTech service or caster cart off-road, over cords/zip ties, and onto the trailer with ease
- Retrofit an existing cart by purchasing a HalfAss Caster kit online, or check out our HalfAss Service Carts

Contact: 715-355-8842
ctechmanufacturing.com



**CTEK POWER INC.
CS FREE**

- Multi-functional, 4-in-1 portable battery charger, maintainer, adaptive booster and powerbank
- Charge and maintain any 12V lead acid or lithium (LiFePO4) battery anywhere using a power outlet, solar panel or 12V service battery
- If your battery is dead, CS FREE's revolutionary Adaptive Boost technology gives you a safe start within 15 minutes

Contact: 800-941-7611
smartercharger.com



The Performance Advantage.



TOUGH COATINGS PERFORM

Coating Solutions:

- Calico D
- Calico D-2
- Chromium Nitride (CrN)
- Diamond Like Carbon (DLC)
- Teflon®
- Titanium Nitride (TiN)

A company built by racers, for racers.

Calico's range of thin film coatings increase the performance of your parts, reducing the friction that causes wear and increasing your speed on the track.

CalicoCoatings.com | 704.483.2202 | Connect with us online.  



Diamond Like Carbon (DLC)

- Ultra low coefficient of friction
- Uniform in thickness
- High chemical resistance
- Corrosion protection

Chromium Nitride (CrN)

- Extreme hardness
- High heat resistance
- High chemical resistance
- Oxidation resistance

Get Calico coated parts from these partner brands:



Billet Style Caps

JAZ Products

MAN O' WAR FUEL CELL BY JAZ

www.JAZProducts.com
800-525-8133

CALL FOR FREE CATALOG!



fluidampr THE ORIGINAL
SFI FOUNDATION INC. MEMBER



CWT INDUSTRIES LLC
MULTI-BAL 5500
CRANKSHAFT BALANCING
MACHINE

- #1 Selling Crankshaft Balancing Machine for the last 22 years

Contact: 800-449-1849
cwtindustries.com



CYLINDER HEAD ABRASIVES
PORTING & POLISHING
SUPPLIES

- Long-shank carbide burrs, cartridge rolls, porting stones, finishing buffs, flap wheels, brushes, flexhones, specialty tools, and kits

Contact: 916-638-1212
ruffstuff.com

UNITED

1 RACE PARTS®

YOUR PIT EQUIPMENT HEADQUARTERS

FEATURED PRODUCTS

<p>DP6000-LH SPLINE</p>  <p>Paoli's patented spline drive has now been applied to the DP6000. Increased socket engagement offers more torque and smoother operation.</p>	<p>GDS SEAMLESS WALLING</p>  <p>Seamless aluminum garage & hospitality walling. Completely customizable to your layout needs with graphics, LED's, logo lights, TV's, storage, doorways and more.</p>	<p>200L FUEL BOWSER</p>  <p>Accurately pump fuel in and out of the car or fuel rig. The built in load cells integrate with the Greaves Fuel Timer Management Software.</p>
--	---	--



704.508.1667 // [f](https://www.facebook.com/UnitedRaceParts) [i](https://www.instagram.com/UnitedRaceParts) [y](https://www.youtube.com/UnitedRaceParts)
UnitedRaceParts.com

North America's exclusive distributor and service center for:





VISIT US AT PRI BOOTH #917



DEFIANT METAL PREMIUM TIG WELDING GLOVES

- Black goatskin material
- Suitable for TIG and light-duty MIG welding
- Single-layered fingers for maximum feel
- Double-layered palm rest provides an extra bit of time to finish that last inch of weld

Contact: 336-701-2731
defiantmetal.com



ECLIPSE SURFACE TECHNOLOGIES ECO-FLEX ECO-100 COMBO ABRASIVE BLASTER

- Combo (vapor or dry) abrasive blaster
- Multi-media capabilities
- Also available paired with an ECO-Aire Dryer or part of our complete turnkey, tow-behind system
- Rugged, portable, and easy to use
- Supports a wide variety of specialty nozzles
- Integrated water pump
- Less media and water consumption than our competitors

Contact: 833-326-3539
eclipseblast.com

EXTREME

POWER, QUALITY & RELIABILITY!

STREET & STRIP



Available for:

- Chevrolet - Chrysler - Oldsmobile
- Ford - Pontiac - AMC

- American made quality & performance
- Not the cheapest, just the Best
- Oil 100% controlled even on rough tracks
- 7 quart capacity

SMALL BLOCK CHEVY OIL PUMP

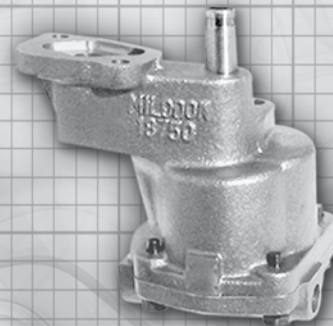

DRAG RACE

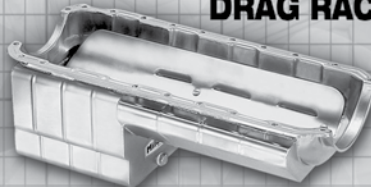

Stock Pump



Milodon Pump

Fits most all chassis, full kickout has superior oil control and power output.

- SB Chevy - 31167
- BB Chevy - 31187
- BB Chevy/Dipstick - 31188
- BB Chevy 4.75 Stroke - 31183
- Ford, Fox Chassis
- 302W - 31121 • 351W - 31122
- Pro Competition - Stepped Sump*

- Built With Fifty Years of Engineering Expertise
- 40,000 PSI "G-10" Housing Material & Strengthened Neck End Pump Breakag
- Designed for Both Low & High RPM Performanc
- CNC Machined for Precise Tolerances
- Every Pump is 100% Flow Tested
- High Volume & Stock Volume Models Available
- Priced for Everyday Engine Rebuilds

NOTHING COMPARES TO THE BEST...

805-577-5950

2250 Agate Court
 Simi Valley, CA 93065

www.milodon.com



LESS WEIGHT = PERFORMANCE

Bill Mitchell Products creates nothing but the best blocks from 357-T6 Aluminum as our standard.

Check Out Our Huge Selection Of High Performance Parts at BillMitchellProducts.com Or Call 386.957.3009

BMP HARD CORE RACING
 BILL MITCHELL PRODUCTS

LS
 SBC
 BBC
 409
 SBF
 HEMI
 WEDGE



SEALING CHANGES EVERYTHING.

MLS SPARTAN™

Multi-Layer Stainless Steel Head Gaskets. Strong, simple to use and ready for battle. Trouble-free, bolt-on performance **without extra sealants.**

MLS SPARTAN™

WITH GAS-STOPPER™ OPTION

Semi-extra layer around the cylinders with precisely-calculated thickness to locate increased clamp-load to seal greater combustion pressures.

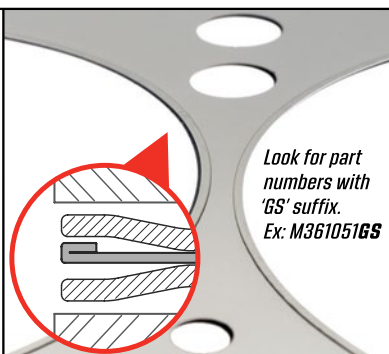

ATHENA-SCE INC | Since 1990 | 800-GASKET-0 | SCEgaskets.com | f t i

**CONNECT
WITH PRI**



@myprishow

CHAMP PANS

QUALITY RACING PRODUCTS by JR Mfg.



We offer over 1,000 high performance products used in Racing, Street, Off-Road and Marine for Chevrolet, Chrysler and Ford applications.

715-834-7748 Visit Our Website www.champpans.com

Email Us: jrmfg@champpans.com



FIRMAN POWER EQUIPMENT ZERO E PORTABLE EXPANDABLE POWER STATION

- Lithium iron phosphate batteries with fast charge capability
- Go from 0% to 80% state of charge in one hour
- Rated for more than 4,000 charge cycles
- Slide-lock expandability—add up to 10 additional batteries
- 30-amp, RV-ready outlet
- Charge on 120V AC, 12V DC, 400W solar
- 2000W continuous, 4000W peak, 1040Wh

Contact: 602-625-3688

firmanpowerequipment.com



FMB MACHINE 40 AND 50 TAPER TOOL RACKS

- Built to provide flexibility, function-ability and ease of use
- Allows you to see all of your tools in one glance, providing easy and ergonomic access to your tooling quickly and efficiently
- Uses only 4 square feet of floor space providing maximum floor space utilization for efficiency and profitability
- 50 Taper Tool Rack holds 65 tools
- 40 Taper Tool Rack holds 84 tools

Contact: 330-571-5519

fmbmachine.com



GLADIATOR PARTS WASHERS
GLADIATOR PARTS
WASHERS BY ARNOLD
MACHINE

- Gladiator Parts Washers are a powerful line of pre-engineered cleaning systems
- Designed and built in-house using high quality and durable materials
- These robust washers employ industrial grade, environmentally responsible cleaning and unparalleled reliability
- Easy to use and maintain
- Lifetime guarantee on 304 stainless steel exterior
- Two-year warranty on replaceable parts

Contact: 419-443-1818
arnoldmachine.com



HASTINGS AIR ENERGY
CONTROL INC.
FUMEVAC

- Weld fume extraction at the source
- FumeVac high-pressure/high-capacity systems
- MIG guns, vacuums, hoods, booms, and accessories protect welders from hexavalent chromium, manganese, and other harmful contaminants
- Performs in the most challenging of welding environments
- Meets ACGIH lower recommendations
- Independent sampling study available
- "Action in Extraction" video library

Contact: 262-364-0500
hastingsair.com

The Small Block That's Built For Big Power

Motown II

- High density cast iron construction
- Priority main oiling system
- Bores to 4.185" (3.995" or 4.120" std.)
- Thick siamese cylinder walls
- Clearance for 4.000" stroke crank
- Nodular or billet splayed 4-bolt main caps w/dual register & ARP fasteners
- Provision for dry sump oiling

#RealWorldResults

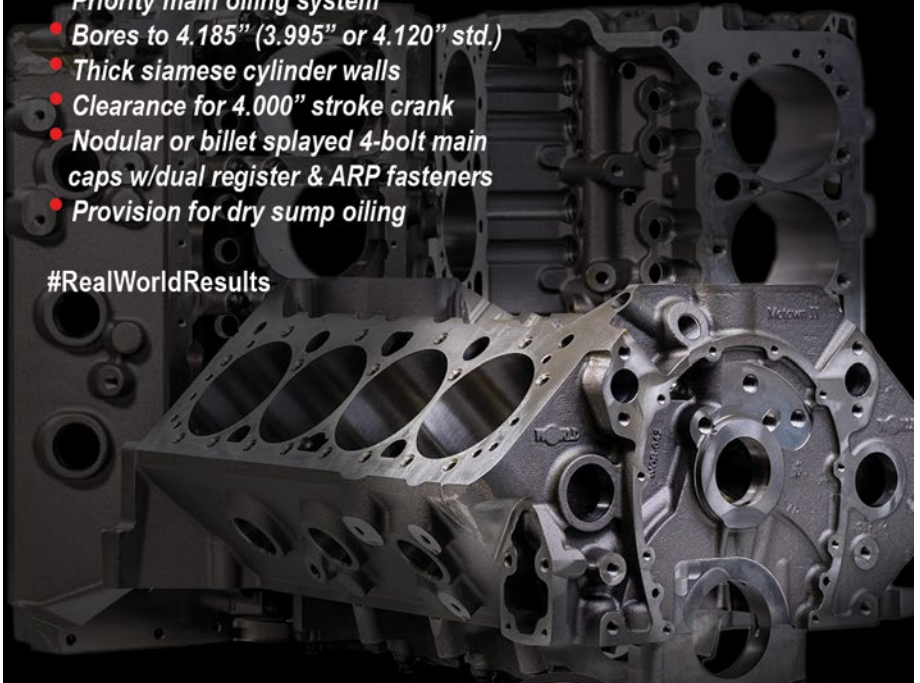

Follow us on:



@jbmersonworld



FBM Performance Products
ERSON Cams
World Products



World Products blocks
use ARP fasteners



MADE IN THE USA
RACE ENGINE COMPONENTS

worldproducts.net

877-630-6651



INTRODUCING THE
2020 REDESIGNED
DIESEL ROD LINEUP

- DESIGNED FOR 2500HP

- INCLUDES POCKET
UNDERPIN END

- AVAILABLE FOR ALL BIG 3:
DURAMAX, CUMMINS,
& POWERSTROKE



949.567.9000

WWW.CP-CARRILLO.COM



VAC MOTORSPORTS

Billet Engine Blocks

- High Strength 6061-T6 Aluminium Block
- Extreme Weight Savings over Factory Iron Block
- Can Stand 1500+ Horse Power
- S14 | S38 | M50 | M52 | S50 | S52 | S54 Applications

Stroker Kits

- Rally | Drag | Hill Climb | Road Racing | Drifting
- S14 | S38 | M50 | M52 | S50 | S52 | S50B30 | S50B32 | S54 | S65 | S85 Applications

Clutch + Flywheel Kits

- Rally | Race | Carbon Clutches
- Lightweight Flywheel Included!
- Twin + Triple Disc Clutches in 5.5" + 7.25"

Billet Differential Covers

- Available for E36, E46 M3, E9x, Z4 / Supra
- Increased Oil Capacity and Cooling
- Improved Strength over Factory Cast Cover

www.VACmotorsports.com
+1 (215) 462-4666 sales@vacmotorsports.com



CANTON RACING PRODUCTS

CARBURETOR ADAPTERS AND SPACERS
OIL AND FUEL FILTERS
PERFORMANCE OIL PANS AND ACCESSORIES
OIL FILTER ADAPTERS AND MOUNTS
ACCUSUMP™ OIL ACCUMULATOR
COOLANT ACCESSORIES
VALVE COVERS
ALUMINUM TANKS

203-481-9460
www.CANTONRACINGPRODUCTS.COM
Made In U.S.A.



IDIDIT PERFORMANCE
Lightweight Steering Columns and Accessories

Quick Release Steering Hubs

Pro-Lite Steering Column
Pro-Fab Steering Column

Quick Release Steering Hubs

- American Made
- SFI Certified
- Available in 3, 5, or 6 bolt designs
- Quick and easy install using factory dash mounts
- Machined with extremely tight tolerances that eliminate backlash for tight steering and feel
- Center pin design ensures a perfect wheel centering every time

Lightweight Steering Columns

- American Made
- Engineered for superior fit, finish, and performance
- Save up to 20 pounds of weight
- Quick and easy install using factory dash mounts
- Pro-Lite Series can go from street to strip featuring turn signals, 4-way flashers, and wiring plug
- Pro-Fab Series includes components to retain original column shroud keeping the stock appearance

IDIDIT LLC., 610 S. Maumee Street, Tecumseh, MI | 517-424-0577 | ididit.com



HERITAGE-CRYSTAL CLEAN MODEL 2734 AGITATING ULTRASONIC PARTS CLEANER

- The Model 2734 ultrasonic parts cleaner is an automated, high-efficiency cleaner that utilizes ultrasonic vibrations for in-depth precision cleaning to break down soils in every nook and cranny
- This simple-to-use, programmable cleaner takes what once were hours-long, labor intensive cleaning efforts and speeds up the process to take as little as 15 minutes

Contact: 630-333-5901
crystal-clean.com



HUTH-BEN PEARSON INTERNATIONAL LLC HUTH HB10 BENDER AND TOOLING PACKAGE

- Comes with comprehensive tooling package 1-1/2" to 3" and instructional DVD
- Easy-to-use knee pad control and manual depth-of-bend indicator
- 58,000 pounds of tube bending power—more than enough for 3-inch tubing
- Flat tool tray
- Heavy-duty double ended swager/expander cylinder for both solid and segmented end forming

Contact: 800-558-7808
huthbenders.com



**JD SQUARED INC.
XR6 CNC ROTARY CUTTER**

- CNC plasma cut tubing, pipe, square, rectangle, channel, and angle iron
- Max material size: 6 inches; standard length: 24 feet
- Plasma cutting, routing, drilling, and marking options
- Comes standard with through coolant system
- Ethercat brushless servo motors on all axis

Contact: 423-979-0309
jd2.com

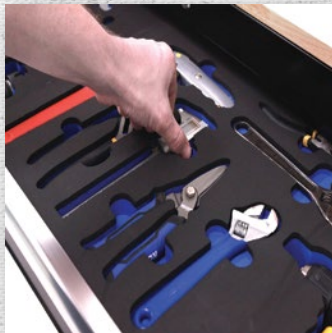

**KAISER MANUFACTURING
KAIZEN SHADOW FOAM
FOR TOOL CONTROL**

- Custom foam inserts for tool control, organization and travel cases
- Portable 3D scanning technology quickly creates a unique design for any mix of tools and gauges
- Professional-grade insert that is superior to hand-cut tool foam in both function and appearance

Contact: 855-919-3626
kaisermanufacturing.com

Trick Flow® Specialties

Put Trick Flow to Work for Your Team!

Trick Flow Specialties: Affordably-priced, premium-quality, high performance engine products capable of delivering maximum power.

Trick Flow Dealer Advantages Include:

- Immediate Access to Industry-Leading Performance Engine Parts and Accessories
- High Profit Margins
- Direct Buy Accounts
- New and Improved Products
- Technical Assistance from Experienced Racers and Engine Builders
- Worldwide Distribution

PRI BOOTH
#2939
Dec. 8–Dec. 10

Stock the best-designed, best-performing engine components available and increase your profits—you owe it to yourself.



Trick Flow pays contingency in the NHRA on all Trick Flow cylinder heads, and in the NMRA, NMCA, and IHRA on all Trick Flow cylinder heads and intake manifolds.

Trick Flow Specialties
1-888-841-6556 • TrickFlow.com



2212PRTF



SPORTSMAN ALUMINUM SHAFT ROCKERS

Since their release in 2001, Jesel Sportsman Series rocker systems have proven themselves to be the ultimate replacement for inadequate stud rocker assemblies on OEM and aftermarket cylinder heads. No modification. No aggravation.



For additional product details, visit us online at Jesel.com or contact us by phone at 732.901.1800

NEWLY ADDED VISIT US AT BOOTH **7167**



Auto Tec
PISTONS

**AFFORDABLE 2618 FORGED
PISTONS FOR CHEVY LS 15°/12°,
SBC, HEMI, & SB FORD**

FOR THE HIGHEST QUALITY, PRECISION MANUFACTURED PISTONS

15681 COMPUTER LANE, HUNTINGTON BEACH, CA 92644 | RACETECPISTONS.COM
PHONE 714.903.4362 | FAX 714.903.4318

**PRI MEMBER
BENEFITS**

**10% DISCOUNT
OFF PURCHASE**

**COMP
CAMS**

**JOIN
TODAY!**

**PRI
MEMBERSHIP**

VISIT:
PERFORMANCERACING.COM/MEMBERSHIP

**TWO-SIDED
THERMO GUARD FR**

**PROVIDES GREATER CLIMATE PROTECTION
TO THE VEHICLE'S CABIN AREA**

**COOL IT.
Thermo Tec**

**MADE IN
USA**

Visit us at PRI Booth 1836

Enter code **PRI20** to receive 20% off your order at ThermoTec.com
(800) 274-8437 www.ThermoTec.com

Available at: **NAPA** **Summit** **JEGS**



**LARSON SYSTEMS INC.
VALVE SPRING TESTER**

- LSI's Valve Spring Tester will be an indispensable part of your engine maintenance
- Compression testing of force and length
- Standard 5-inch range/stroke
- Standard 0.001-inch length resolution
- Up to 4 inches Ø platform (2 inches standard)
- 200 lb-ft, 750 lb-ft, and 1,500 lb-ft load capacities
- Built-in length deflection compensation

Contact: 763-780-2131

larsonsystems.com



**MASTERCAM
MASTERCAM 2023**

- Increased machining productivity and reduced overall production costs
- Faster, more flexible multi-axis programming
- Modeling advances
- Enhanced intelligence and automation

Contact: 860-875-5006

mastercam.com



**MEC CNC MACHINES
SG8XL SMART SEAT AND
GUIDE MACHINE**

- Cut valve seats to equal depth without taking hands off the wheel
- From smallest to largest cylinder heads on one machine
- Precision airfloat centering for minimum valve seat run-out
- CVS - Constant Varying Spindle Speed for chatter-free finish
- Dual axis level with digital display

Contact: 949-800-7176
meccnc.com



**PERFORMANCE CBN
CBN/PCD ULTRAHARD
CUTTING TOOLS**

- CBN and PCD surfacing inserts
- Newen inserts for iron and powdered metal seats
- PCD inserts with chip breakers for turning aluminum
- Milling cutters for aluminum
- Solid carbide valve seat reamers and pilots
- CNC porting tools
- O-ring milling cutters
- Taps

Contact: 269-217-4262
performancecbn.com



**Northern®
RADIATOR**

**Trust Northern to Keep Things Cool
While You're Heating Up the Track!**

Whatever your race application needs, Northern is up for the cooling challenge! Whether it's circle track, dirt, off-road, or drag racing, we've got high quality radiators, fans, shrouds, and more to help keep your temperature in check so you can do what you do best.

Need help finding the right products to fit your application?

Give us a call and let our knowledgeable customer service staff guide you to the right products to meet your cooling demands.



**Call or Visit
Us Online Today!**

1-800-328-8900 • www.NorthernRadiator.com

TOTAL TRANSMISSIONS CHICAGO
totaltransmissions.com

"REMANUFACTURED EXCELLENCE"

TOTAL TRANSMISSIONS CHICAGO
2601 GRANT AVE
BELLWOOD, IL. 60104
708-493-0160 EXT 104 OFFICE
708-510-2364 CELL
JUSTIN@TOTALTRANSMISSIONS.COM

NON BILLET STALL SPEEDS
700R4 / 4L60E / 4L65E / 4L80E / TH350 / TH400 / 4L80E / 6L80 / 6L90

BILLET STALL SPEEDS

DROP IN READY REBUILT PUMPS

CUSTOM STALL SPEEDS AVAILABLE
R&R SERVICE FOR PUMPS AND CONVERTERS



www.radialbearing.com
sales@radialbearing.com

PROVEN IN THE AIR...

- Aircraft Quality ROD END and SPHERICAL BEARINGS
- Self Lubricating (PTFE) and Metal-to-Metal
- Alloy and Stainless Steels
- Specials for Specific Engineering Needs

PROVEN ON THE TRACK...

1-800-377-1937 for a free catalog
Fax: (203) 744-1691

AS9100 / ISO 9001



PERFORMANCE PLUS - THE LEADING EDGE CBN VALVE REFAZER AND TIPPING WHEELS

- 21st century engine valve grinding at its best
- Grind all materials and do it well, dozens of valves before dressing titanium, Inconel, stainless, etc., Rottler, Robins, Sunnen, Kwikway, Sioux

Contact: 618-322-7587

perfplustle.com

**PRI MEMBER
BENEFITS**

10%

**DISCOUNT
OFF PURCHASE**

Edelbrock

**JOIN
TODAY!**



VISIT:
PERFORMANCERACING.COM/MEMBERSHIP



PERSONAL POSITIONING TECHNOLOGIES LLC POWER SHOP CHAIR

- Eliminates bending, stooping, and crawling
- Reduce sprains and strains
- Eliminate repetitive motion injury and cost
- Increase quality and productivity
- Designed and built in the USA
- Runs on rechargeable Li-Ion batteries
- Work in comfort, reduce fatigue
- Smooth rolling non-marking casters
- Constructed of stainless steel and aircraft aluminum

Contact: 989-798-0220

personalpositioningtechnologies.com



POINT ONE

HIGH PERFORMANCE FASTENERS

**PRISHOW
BOOTH 1936**

- MADE IN AMERICA
- VERTICALLY INTEGRATED MANUFACTURING IN-HOUSE
- MANUFACTURED TO THE MOST PRECISE STANDARDS FOR HIGH PERFORMANCE MARKETS
- SUPERIOR CUSTOMER SERVICE WITH FAST DELIVERY

P1MFG.COM

417.753.5174



**PRO ULTRASONICS
PRO 4230LT LIFT TABLE**

- 120-gallon ultrasonic cleaning system with agitating lift-table for large engine parts, diesel heads, and more
- Touchscreen control panel for effortless, hands-free cleaning
- Non-hazardous soaps, hands-free, fast cleaning
- Best investment your shop will make

Contact: 828-237-1735
proultrasonics.com



**OMP RACING ENGINES
MC-1 AND SF-1**

- The MC-1 is used for measuring piston skirt diameters and so much more
- The SF-1 is a true setting fixture for Mitutoyo and Sunnen bore gauges

Contact: 818-576-0816
qmpracing.com

GrandBending.com



**MANUFACTURED for
PERFORMANCE**

Our team has specialized in fabricating custom and high-performance exhaust systems for race cars, vehicle restylings, and restorations for over 20 years. All products are proudly crafted in the USA, available in aluminized carbon steel and stainless steel thin-wall tubing, and utilize short radius tube bends measuring 1½–5 inches.



Need more info? Let's chat! Visit GrandBending.com or call or email one of our representatives today.



PH 770-426-0734
sales@grandbending.com

1092 West Atlanta Street, SE, Bldg. 1200 Marietta, Georgia 30060



Argo Manufacturing Co.

Argo introduces a line of **Lower Control Arm Bushings** to go along with our quality line of Lower Control Arms.

- Manufactured to our high standards
 - Made from high quality steel
- You now have a complete package for all the parts for your Lower Control Arm needs.*



P.O. Box 359 • 4N944 Old LaFox Road • Wasco, Illinois 60183 • www.argo-pace-rapco.com
800-327-3552 or 630-377-1750 • fax: 630-377-0274 • sales@argo-pace-rapco.com

Simplicity, Universality.

Multi-Jig

PRI SHOW
SPECIAL!Multi-Jig Welding
Table Kit

\$1,999

27-35 in adjustable table height
• 2,200 LBS carrying capacity •
M8 tapped table top holes

Offer Valid: Dec 8th - Dec 31st 2022

DOCOL R8 TUBES
DOCOL SHEET METAL
CHASSIS COMPONENTSPRI BOOTH
#7166PRI MEMBER
BENEFITS

15%

OFF ANY
JMS CHIP AND
PERFORMANCE
PRODUCTJMS
JMSCHIP.COMJOIN
TODAY!VISIT:
PERFORMANCERACING.COM/MEMBERSHIP

Clarendon

Specialty Fasteners Inc.

The home of Motorsport brands:
AEROCATCH | AEROLOC
and a leading supplier of
AEROSPACE FASTENERS

AeroCatch

6 & 12 Point
Aerospace Nuts

AeroLoc

Aerospace
Hardware

CONTACT US:

714-842-2603

www.clarendonsf.com

usasales@clarendonsf.com

SERVICE PRECISION
GRINDING INC.MODEL 82-B TDR/SRD
DRILL GRINDER

- Sharpens drills 1/16 inches – 1 1/2 inches
- Enhance radial relief
- Sharpen HSS, cobalt, and carbide
- Optional endmill refacing
- Optional tap-reamer

Contact: 315-776-9602

drill-grinder.com



**SHAVIV USA
FR RATCHETING
COUNTERSINK SET**

- The solution for quick deburring and countersinking of drilled holes
- Features a 20-mm countersink and a ratcheting holder that helps avoid hand fatigue
- Compatible with the F26X chamfering cone for deburring outside edges on pipes and tubing

Contact: 630-296-0102
shaviv.com



**SHOP CRANE BY GORBEL
SHOP CRANE**

- A complete crane hoist system that can be used in a residential garage or workshop
- Great for vehicle restoration, maintenance on farm or golf course equipment, or getting your car, ATV, snowmobile or any other motor driven vehicle ready for action

Contact: 855-992-7263
shopcrane.com



**YOUR #1 SOURCE FOR
CHEVY POWER**

SDPC
SCOGGIN DICKEY PARTS CENTER

*One of the Largest Chevy Performance
Parts Warehouses in the USA
In-House Machine Shop and Dyno Services
Custom Race and Street Engines*

 **PERFORMANCE**
CHEVROLET VEHICLES / PARTS / RACING

1-800-456-0211 • SDParts.com

VISIT US AT BOOTH #4425

CELEBRATING



1982-2022

**H&W Machine Repair
and Rebuilding**

**Full Service Machine Rebuilds |
Machine Parts | Acu-Rite DRO |
Servo Products | Bijur Lube |
And Many Other Parts and
Services!**

www.MachineryPartsDepot.com | 1-800-285-5271



SLIDELITE LLC THE ORIGINAL SLIDELITE

- Simple solution that lightens your workload by sliding a flashlight onto your socket extension
- Proudly made in the USA
- Made from 6061 aluminum
- Created by a longtime mechanic after dropping the flashlight for the last time
- Frustration over this common problem led to this simple, yet highly effective solution

Contact: 937-234-3906
theoriginalslidelite.com

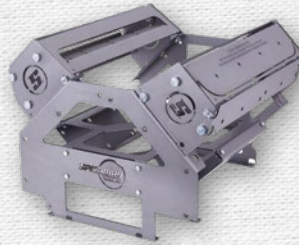

SPEEDWAY MOTORS LIGHTWEIGHT LS ENGINE DUMMY BLOCK MOCK-UP KIT, LONG BLOCK

- Compatible with all LS engine bolt-ons such as intake manifolds, headers, oil pan, timing cover, water pump, and accessory brackets, which makes positioning or fabricating engine mounts a breeze
- Test fit your LS swap quickly and easily without the need for an actual engine
- Part #: 91089660-LONG

Contact: 800-333-7223
speedwaymotors.com

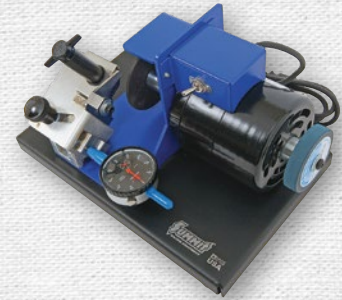

SUMMIT RACING EQUIPMENT SUMMIT RACING PRO RING FILERS

- For engine builders looking for accurate and affordable equipment
- Produces even grinds with no highs or lows
- Accurate to .001 inch
- Available with 110 V or 220 V motors
- Wide variety of colors available
- Includes deburr wheel and wheel dressing tool
- Designed and made in the USA with American-made materials

Contact: 800-230-3030
summitracing.com



TECHNOCRAFT CABINETS LLC MICRO TOOLBOX

- All drawers come with ball bearing slides and a proprietary side latch system
- The top six drawers have 200# ball bearing slides; the bottom two drawers have double 200# slides
- All feature .080 aluminum construction with no welded seams to flex and crack

Contact: 931-379-5500
trailer cabinets.com



THG AUTOMATION LLC UR + FRONIUS CMT MIG WELDING SYSTEM

- Merges the collaborative robot capabilities of Universal Robots UR10e with industry leading weld process control of Fronius TPS/i welding solutions
- Capable of welding aluminum, carbon steel, and stainless steel
- Offers the widest lists of welding processes such as synergic pulse, synergic pulse with Syncro-Pulse, CMT, CMT mix drive, CMT cycle steps, PMC, PMC mix drive, and more

Contact: 317-593-5575
thgautomation.com



UNITED RACE PARTS TIRE SCRAPER

- Avoid damaging tire compound by using unsuitable tools or excessive temperature
- Removes pick and debris with ease leaving a smooth undamaged surface

Contact: 704-508-1667
unitedraceparts.com



**VAN NORMAN MACHINE
INDIA PVT LTD.
VALVE SEAT & GUIDE
MACHINES—SMART SERIES**

- Achieve equal depth valve seats without using any switches, looking at the Smart screen, setting mechanical stops, nor using any dial indicators

Contact: 91-99-155-44777
robinsmachines.com



**WALTON CO.
WALTON TAP EXTRACTORS**

- Remove broken taps without drilling, lasers, damaged threads, scrapped parts or repair inserts—and save the threads
- Available in every tap size—both inch and metric—as handy sets (Set No. 15 shown) or individual pieces
- Proudly made in the USA

Contact: 860-523-5231
wالتontools.com



**VYPER ENGINEERING, LLC
VYPER LAY DOWN CREEPER**

- Built on an aluminum frame with steel support bars
- Features four 4-inch industrial-grade rollover casters with guards, an adjustable 6-inch x 8-inch headrest, and extremely durable Smart Fabric upholstery

Contact: 920-323 9832
vyperchair.com

PRI MEMBER BENEFITS

10%
**DISCOUNT ON ALL
PRI MERCHANDISE**

**VALID ON WEBSITE ONLY*



JOIN TODAY!

VISIT:
PERFORMANCERACING.COM/MEMBERSHIP



PRI MEMBER BENEFITS

10%
**DISCOUNT TO ALL
PRI MEMBERS
THROUGH WEBSITE**

(www.SPPEdiagnostix.com)



How To Know You're Good To Go.

JOIN TODAY!

VISIT:
PERFORMANCERACING.COM/MEMBERSHIP





SECTION

5

RACE TRACK EQUIPMENT

Management at road courses, large and small ovals, and drag strips across the US and around the world can benefit from new equipment and services designed to improve their programs through better track conditioning, communications, safety, or elsewhere. A select group of these providers offer the very best in solutions for race venues and teams representing nearly all forms of competition.

INNOVATIVE SPECTATOR PRODUCTS

raceceiver.com | 866-301-7223



LITECEIVER

- Wireless flagging
- Control the entire field with a simple button press
- Simple, rugged and rechargeable
- Roll bar mounted
- Bright flag status LEDs
- Long range radio
- Extended range repeater option
- Encrypted channels
- The circle track, karting and offshore solution



ELEMENT

- The all-weather communications solution
- Water and dust resistant
- Internal rechargeable battery
- Safety and efficiency
- Race officials broadcast directly to drivers
- Allows faster line-ups and restarts
- Instant notifications of track conditions
- Coaches provide instant feedback
- Improve skills and overall performance
- Motivate with supportive statements for good performance



FUSION +

- The gold standard in communication
- Button lock
- Louder audio
- Narrow band radio compatible
- Race officials broadcast directly to drivers
- Allows faster line-ups and restarts
- Instant notifications of track conditions
- Coaches provide instant feedback
- Improves skills and overall performance
- Motivate with supportive statements for good performance



FLAGGER IN-CAR ALERT

- The road course flagging solution
- FIA in-car flagging
- Corner lights
- GPS local flags
- Global flags
- Direct driver messaging
- Touchscreen and rechargeable
- Code 35 with GPS speed
- Stop on track/incident
- 50 hz data collection
- EV and tow tracking

PRI
PERFORMANCE RACING INDUSTRY

CONNECT WITH PRI

f t i n i g

PRISHOW.COM/SOCIAL

VISIT THE PERFORMANCE RACING INDUSTRY WEBSITE

—

LEARN MORE ABOUT:
TRADE SHOW
MEMBERSHIP
MAGAZINE
ROAD TOUR
ADVERTISING
INDUSTRY NEWS

PRI
PERFORMANCERACING.COM



ALITRAX RACE CIRCUIT CONTROL & TRACK PERFORMANCE SYSTEMS

- Circuit safety lighting, control systems, and information management solutions
- Catering to all race circuits, club circuits and motorsport competitions around the world
- LED flag and start light panels, information display panels, control software, environmental and circuit monitoring
- Global consulting and technical support

Contact: +61 7 3245 6514
alitrax.com



COMPUTECH SYSTEMS INC. RACEAIR CLOUD

- Trailer racing weather station with texting
- Used by nearly all NHRA professional teams
- Comes with all mounting, storage, and cabling
- Comes with RaceBase electronic logbook software
- Customizable ET prediction and run completion
- Prediction report card to fine-tune formulas
- Jr. Dragster ET, weight index and tuning prediction
- Best-in-industry evening and weekend tech support

Contact: 301-884-5712
comutech.com



PIT-PRO CUSTOM CARTS CUSTOM PIT VEHICLES

- Custom golf carts for pit transportation
- Custom push bars and tow packages
- Variety of wheel packages
- Bluetooth audio, LED lighting
- Paint colors and full vinyl wraps
- Custom upholstery, logo embroidery
- Multiple rear seat options
- We understand trailers and transport of carts
- You ask, we build to your needs

Contact: 317-858-1830
pitprousa.com



PROFESSIONAL MOTORSPORTS SOLUTIONS TRACK/SERIES RESOURCES

- Several products that tracks and series need to operate
- Timing systems, radios, scoreboards, sublimated shirts, and much more

Contact: 704-644-0883
professionalmotorsportsolutions.com



ROCKET TRACK PRODUCTS / ENVIRONMENTAL PROTECTIVE COATINGS ROCKET TRACK GLUE (TRACTION COMPOUNDS)

- Advanced traction compound
- Custom formulations for all surfaces and weather conditions
- Better heat resistance
- Larger spread rate
- A concentrated form of Rocket Prep traction compound, RTG3X Concentrate allows the track to cut the product more—or less—depending on track conditions
- Fill in bald spots on the track with RTG Thrust Dust powder resin

Contact: 740-363-6180
rockettrackproducts.com



ROWE ELECTRONICS INC. DOZER ISM

- Dozer Integrated Strobe Module from Rowe Electronics works with most popular standard LED lighting
- Solid state environmentally sealed
- Easy install with a small form factor
- Drive up to four LED lights with four configurable combinations
- Retains OEM turn signal function in both on and off states

Contact: 515-981-5504
rowe-electronics.com



**TOTAL VENUE CONCEPTS
14' VALUE \$PRAY TRACTION
COMPOUND SPRAYER**

- Sprays 2.5', 5.5', 8' or 14' wide
- One-man operation with the ability to adjust the width on the fly
- 15 precision nozzles provide an atomized coverage at 15 to 80 PSI
- Dripless nozzles for no-mess operation
- Sturdy yet lightweight aluminum channel beam frame provides an open design that is easy to clean and maintain
- Breakaway spray bar design

Contact: 419-677-3023

totalvenueconcepts.com



**TRACKSIDE SYSTEMS
TRACKSIDE TICKETING
AND EVENT TECHNOLOGY**

- The only system you need to run your motorsports events
- Wi-Fi networks
- Point of sale
- Online ticketing
- Text messaging and email marketing
- Digital waivers and tech cards
- Coupons/promotions
- Analytics and reports
- Website and hosting

Contact: 330-754-3364

tracksidesystems.com

H O O K E D O N M O T O R S P O R T S ?



Become a member of Performance Racing Industry and join the first-ever community of its kind.

Now available to racers and motorsports enthusiasts, PRI Membership is designed to bring the industry together, and protect racing by advocating on our collective behalf.



W I N N I N G T O G E T H E R

YOUR MEMBERSHIP INCLUDES AMAZING BENEFITS

GO TO:

performanceracing.com/membership

TO LEARN MORE



A person wearing a racing helmet and suit is celebrating with their arms raised in the air. The background is a solid red color. The person's suit has some logos, including "tilo" and "PEAK".

SECTION

6

SANCTIONING BODIES

Helping to ensure a level playing field for participants, these organizations regulate and coordinate the events and series that fall under their authority. As de facto governing bodies, they partner with member tracks, develop and enforce rulebooks, penalize infractions, run sponsorship and contingency programs, manage payouts, and generally work to keep drivers, crew members, spectators, and others safe while maintaining fair and equitable competition.

24 HOURS OF LEMONS

5675 Horton St., Ste. C
Emeryville, CA 94608
844-288-8227
24hoursoflemons.com

REGION: CA, CO, GA, IL, KY, MI, NH, TX, WA
TYPE: Endurance Races For \$500 Cars, Car Shows, Road Rallies

500 SPRINT CAR TOUR

765-642-0206
500sprintcartour.com

REGION: IN, MI
TYPE: Non-wing Pavement Sprint Car Racing

AMERICAN CANADIAN TOUR, LTD (ACT)

105 N. Main St., Ste. 208
PO Box 1002
Barre, VT 05641
802-244-6963
acttour.com

trisha@thunderroadvt.com
REGION: CT, MA, ME, NH, VT & QC, Canada
TYPE: Late Model Sportsman Racing

AMERICAN DRAGCAR

PO Box 14976
Phoenix, AZ 85063
602-741-7809
usdragcar.com
info@usdragcar.com

REGION: AZ
TYPE: Drag Racing

AMERICAN ENDURANCE RACING

americanenduranceracing.com
info@americanenduranceracing.com
REGION: CA, GA, NY, OH, PA, VA, WV
TYPE: Endurance Racing

AMERICAN HOT ROD ASSOCIATION (AHRA)

PO Box 309
Lascassas, TN 37085
615-580-3137
ahraonline.com
dallas@ahraonline.com
REGION: HI, IA, MO, NC, OH
TYPE: Drag Racing

AMERICAN KART RACING ASSOCIATION (AKRA)

7229 Landsford Rd.
Monroe, NC 28112
704-764-8138
akraracing.com
billmcfast@aol.com
REGION: MI, OH, PA, VA, WV
TYPE: Kart Racing

AMERICAN MODIFIED SERIES

98 Jane Ln.
Stout, OH 45684
812-216-9317
americanmodifiedseries.com
dragland44@gmail.com
REGION: IL, IN, KY, OH, TN
TYPE: Dirt Open Wheel Modified

AMERICAN MOTOR RACING ASSOCIATION (AMRA)

25945 Ripley Rd.
Mt. Alto, WV 25264
304-428-5000
amramodified.com
REGION: WV
TYPE: Open Wheel Modified, Late Model, and Sport Modified

AMERICAN POWER BOAT ASSOCIATION (APBA)

39425 Garfield Rd., Ste. 26
Clinton Township, MI 48038
586-773-9700
apba.org
REGION: AZ, CA, FL, ID, KY, MD, MN, NC, NH, NJ, NY, OH, OR, PA, TX, VA, WA, WI, WV
TYPE: Power Boat Racing

AMERICAN RACING DRIVERS CLUB (ARDC)

419 Water St. Rear
Danville, PA 17821
570-411-4692
ardcmidget.com
shannonmausteller@hotmail.com
REGION: DE, MD, NC, NJ, NY, PA
TYPE: Midget Auto Racing

AMERICAN RALLY ASSOCIATION (ARA)

4910 W. 16th St.
Speedway, IN 46224
317-247-5151
americanrallyassociation.org
info@americanrallyassociation.org
REGION: CO, MI, MN, MO, NH, NV, OH, OR, PA, TN, WA
TYPE: United States Stage Rally Racing, 501(c) (3) nonprofit

ATLANTIC COAST OLD TIMERS AUTO RACING CLUB

193 Thompson Rd.
Windsor, NY 13865
607-655-1427
acotnews.org
clubeast@verizon.net
REGION: CT, MA, NH, NJ, NY, PA, VT
TYPE: Antique Race Cars

AUSTRALIAN NATIONAL DRAG RACING ASSOCIATION

11 McInnes St.
Ridleyton, SA 5008
Australia
011-61-8-8271-5355
andra.com.au
info@andra.com.au
REGION: Australia
TYPE: Drag Racing

AUTO VALUE BUMPER TO BUMPER SUPERSPRINTS

109 N. Broadway
Cassopolis, MI 49031
269-445-8616
supersprints.com
tom@supersprints.com
REGION: IN, MI, OH
TYPE: 410 Asphalt Winged Sprint Car Racing

AUTOMOBILE COMPETITION COMMITTEE US/FIA (ACCUS)

825 Ballough Rd., Ste. 200-C
Daytona Beach, FL 32114
386-506-0140
accusfia.us
REGION: CA, FL, IN, KS
TYPE: International Sporting Sanctioning Authority for the US

AUTOMOBILE RACING CLUB OF AMERICA (ARCA)

7980 Lewis Ave.
Temperance, MI 48182
734-847-6726
arcaracing.com
REGION: USA & Canada
TYPE: Stock Cars

BADGER MIDGET AUTO RACING ASSOCIATION

2764 Egge Rd.
Sun Prairie, WI 53590
847-840-1344
bmara.com
info@bmara.com
REGION: IA, IL, MN, WI
TYPE: Midget Racing

BAY CITIES RACING ASSOCIATION (BCRA)

2218 Bluffs Ct.
Livermore, CA 94551
510-376-3338
bcraracing.com
bcraracing@gmail.com
REGION: CA, NV
TYPE: Midget and Midget Lite Racing, and Vintage Division

BEST IN THE DESERT

3475-C Boulder Hwy., Ut. B
Las Vegas, NV 89121
702-457-5775
bitd.com
bitd@bitd.com
REGION: AZ, NV
TYPE: Off-Road Racing

BIG 8 LATE MODEL SERIES

PO Box 1000
Rockford, IL 61105
815-633-1500
big8latemodels.com
info@big8latemodels.com
REGION: IA, IL, WI
TYPE: Short Track

BMW CAR CLUB OF AMERICA

2350 Highway 101 S.
Greer, SC 29651
864-558-5936
bmwccaclubracing.com
kchulkas@bmwcca.org
REGION: USA
TYPE: Car Club

BUCKEYE OUTLAW SPRINT SERIES (BOSS)

2177 Lunbeck Rd.
Chillicothe, OH 45601
740-703-3768
buckeyesprints.com
sprinter14@hotmail.com
REGION: IN, OH, PA
TYPE: Sprint Cars

CALIFORNIA LIGHTNING SPRINTS

24325 Crenshaw Blvd., #146
Torrance, CA 90505
909-437-3170
racecls.com
REGION: CA
TYPE: Sprint Cars

CANADIAN AUTOMOBILE SPORT CLUBS - ONTARIO (CASC-OR)

7250 Keele St., Ste. 413
Concord, ON, L4K 1Z8
Canada
416-667-9500
casc.on.ca
office@casc.on.ca
REGION: ON, Canada
TYPE: Sports Car Racing

CANADIAN TOURING CAR CHAMPIONSHIP

416-707-0358

touringcar.ca
john@touringcar.ca
REGION: Canada
TYPE: Road Racing

CAROLINA CLASH SUPER LATE MODEL SERIES

129 Oakvale Dr.
Easley, SC 29640
910-263-2285
carolinaclash.com
REGION: NC, SC
TYPE: Dirt Super Late Model Racing

CARS TOUR

136 Bridle Path Ln.
Mooresville, NC 28117
704-662-9212
carsracingtour.com
admin@carsracingtour.com
REGION: NC, SC, TN, VA
TYPE: Super Late Models, Late Model Stock Cars

CHAMPCAR ENDURANCE SERIES

8526 SW Westwood Ln.
Stuart, FL 34997
772-485-8252
champcar.org
REGION: USA & Canada
TYPE: Endurance Road Racing

CHAMPION RACING ASSOCIATION

PO Box 502
Salem, IN 47167
812-883-0455
cra-racing.com
lucett@cra-racing.com
REGION: GA, IN, MI, NC, OH, TN
TYPE: ARCA/CRA Super Series Template Super Late Models, JEGS/CRA All-Stars Tour Template Crate Late Models, CRA Late Model Sportsman, CRA Street Stocks

CHAMPIONSHIP CUP SERIES

PO Box 151738
Fort Worth, TX 76108
817-246-1127
ccsracing.us
info@ccsracing.us
REGION: FL, GA, IL, MN, NC, NJ, SC, WV
TYPE: Motorcycle Road Racing (Amateur and Professional)

COMMISSION INTERNATIONALE DE KARTING-FIA (CIK-FIA)

2 chemin de Blandonnet
1215 Geneve 15

Switzerland
41 0 22 306 1080
fiakarting.com
REGION: Europe
TYPE: Karting

COMP CAMS SUPER DIRT SERIES

802 Third Ave.
Conway, AR 72032
419-923-6970
compdirt.com
sully1888@gmail.com
REGION: AR, LA, MS
TYPE: Super Late Model Racing in the South

COOPER TIRES USF2000 CHAMPIONSHIP POWERED BY MAZDA

10101 US Hwy. 41 N.
Palmetto, FL 34221
941-845-2500
usf2000.com
REGION: FL, IN, OH, OR, WI & ON, Canada
TYPE: Open Wheel Racing Series Sanctioned by INDYCAR

CORN BELT CLASH

PO Box 21
West Union, IA 52175
563-380-0665
cornbeltclash.com
info@cornbeltclash.com
REGION: IA, IL, MO, NE, SD, WI
TYPE: Dirt Late Model Series

CRATE RACIN' USA

PO Box 195
Lincoln, AL 35096
678-719-8888
crateracinusa.com
crateracinusa@gmail.com
REGION: AL, AR, FL, GA, LA, MS, TN
TYPE: Crate Motor Dirt Late Model Racing

CRS SUPER TRUCK SERIES

14340 Gaskill Dr. NE
Alliance, OH 44601
216-217-5038
crstruck.com
REGION: IN, MI, NC, OH, WV
TYPE: Pickup Truck Racing

DIRTCAR RACING

7575-D W. Winds Blvd.
Concord, NC 28027
704-795-7223
dirtcar.com
REGION: DE, FL, IA, IL, IN, KY, MI, MO, NE, NM, NY, OH, PA, SC, SD, TX, WI, WV
TYPE: Dirt Late Model Series

EMPIRE SUPER SPRINTS (ESS)

91 Ellen St.
Oswego, NY 13126
315-342-3933
empiresupersprints.com
REGION: NY & ON, Canada
TYPE: Winged 360 Sprint Car Racing

ENGLEWOOD RACING ASSOCIATION

7473 W. Laurel Ave.
Littleton, CO 80128
303-979-2826
erasupermodifieds.wix.com/home
REGION: CO, ID, NE, WY
TYPE: Super Modifieds

FASS BIG RIG SERIES

740-260-9107
bigrigracing.com
info.fassbigrigseries@gmail.com
REGION: MI, NC, PA, SC, VA
TYPE: Diesel Big Rigs Racing

FASTRAK RACING SERIES

8077 Royston Rd.

Carnesville, GA 30521
678-935-7304
fastrakracing.com
office@fastrakracing.com
REGION: GA, IN, KY, MD, NC, OH, PA, SC, TN, VA, WV,
TYPE: Crate Late Models, Dirt Late Models, Super Late Models

FEDERACION DE AUTOMOVILISMO DE PR

Puerto Rico
787-462-8218
fapr1956@msn.com
REGION: PR, Mexico, Central America
TYPE: Drag, Oval Track, Road Rally, Off-Road Rally, NHRA, Quarter Mile, Half Mile

FEDERATION INTERNATIONALE DE L'AUTOMOBILE (FIA)

fia.com
REGION: Worldwide
TYPE: Formula 1, Formula E, World Rally

FLORIDA MINI-SPRINT ASSOCIATION (FMSA)

21103 Reindeer Rd.
Christmas, FL 32709
352-266-1925
flminisprints.com
jtctoys33@aol.com
REGION: Florida
TYPE: Mini-Sprint Racing

FLORIDA POWERBOAT CLUB

1214 SW 6th St.
Pompano Beach, FL 33069
954-545-1414
flpowerboat.com
admin@flpowerboat.com
REGION: Florida
TYPE: High Performance Speed Boats

FORMULA DRIFT INC

2161 Gundry Ave.
Signal Hill, CA 90755
562-901-2600
formulad.com
info@formulad.com
REGION: USA, Canada, Mexico, Central America, South America, Europe, Middle East, Africa, Asia, Australia/New Zealand
TYPE: Drifting

ONE STOP FOR ALL YOUR PERFORMANCE NEEDS



PRP
PHILADELPHIA RACING PRODUCTS



25 YEARS
of manufacturing excellence

American made products —
Supplying the racing industry
for over two decades!

TRACK TESTED
RACER APPROVED!

prpracingproducts.com

Prevent Surface Fretting



DIAMOND CLAW
SURFACE LOCK

Make Loose Flywheel & Damper Bolts A Thing of the Past.
Available For All Popular Applications.

shaftech.com



**FORMULA PRO USA WESTERN
CHAMPIONSHIPS**

711 S. Carson St., Ste. 4
Carson City, NV 89701
888-977-7885
formulaprousa.com
info@exclusiveracing.com
REGION: CA, OR, UT
TYPE: Open Wheel Road Racing

**FORMULA RACE CAR CLUB OF AMERICA,
LLC (FRCCA)**

160 Flying Point Rd.
Freeport, ME 04032
201-665-8682
formularacecarclubofamerica.com
frcca2014@gmail.com
REGION: NJ, NY, PA, WV
TYPE: Formula Car Racing

GLOBAL MX-5 CUP

10101 US Highway 41 N.
Palmetto, FL 34221
941-845-2500
mx-5cup.com
REGION: FL, GA, NY, OH, VA, WI
TYPE: Road Racing

GLOBAL TIME ATTACK

1030 W. Collins Ave.
Orange, CA 92867
562-999-4670
globaltimeattack.com
info@globaltimeattack.com
REGION: USA
TYPE: Time Attack

GOODGUYS ROD & CUSTOM ASSOCIATION

PO Box 9132
Roanoke, TX 76262
800-777-1258
good-guys.com
REGION: AZ, CA, CO, IA, NC, OH, TN, TX, WA
TYPE: Hot Rods and Custom Car Events

GREAT AMERICAN STOCKCAR SERIES

PO Box 10144
Portland, OR 97296
503-519-1041
gasstv.com
REGION: USA
TYPE: Road Racing, Circle Road

HISTORIC SPORTSCAR RACING (HSR)

PO Box 8110
Clearwater, FL 33758-8110
727-573-1340

hsrrace.com
info@hsrrace.com
REGION: USA
TYPE: Vintage & Historic Road Racing

**INDY PRO 2000 CHAMPIONSHIP
PRESENTED BY COOPER TIRES**

10101 US Hwy. 41 N.
Palmetto, FL 34221
941-845-2500
indypro2000.com
info@roadtoindy.net
REGION: FL, IN, OH, OR, WI & ON, Canada
TYPE: Open Wheel Racing Series Sanctioned
By INDYCAR

INDYCAR

4551 W. 16th St.
Indianapolis, IN 46222
317-492-6526
indycar.com
indycar@indycar.com
REGION: USA
TYPE: NTT INDYCAR Series and INDY NXT by
Firestone

**INTERNATIONAL HOT ROD ASSOCIATION
(IHRA)**

PO Box 386
House Springs, MO 63051
855-646-4472
ihra.com
info@ihra.com
REGION: Worldwide
TYPE: Drag Racing

INTERNATIONAL KART FEDERATION (IKF)

33175 Temecula Pkwy., Ste. 233
Temecula, CA 92592
951-491-0808
ikfkarting.com
info@ikfkarting.com
REGION: USA
TYPE: Kart Racing

**INTERNATIONAL MOTOR CONTEST
ASSOCIATES (IMCA)**

PO Box 68
Youngtown, AB, T0J 3P0 Canada
403-779-2218
imcacanada.ca
REGION: Canada
TYPE: Modifieds, Hobby Stock, Stock Car,
Late Models

**INTERNATIONAL MOTOR
CONTEST ASSOCIATION (IMCA)**

PO Box 921
Vinton, IA 52349-0921
319-472-2201
imca.com
raceimca@imca.com
REGION: USA, Canada
TYPE: Modifieds, Sport Modifieds, Late
Model, Sprint, Stock, Compacts

**INTERNATIONAL MOTOR SPORTS
ASSOCIATION (IMSA)**

One Daytona Blvd
Daytona Beach, FL 32114
386-310-6500
imsa.com
info@imsa.com
REGION: USA & Canada
TYPE: WeatherTech SportsCar
Championship, Michelin Pilot Challenge,
Prototype Challenge, Porsche Carrera Cup
North America, Ferrari Challenge Trofeo
Pirelli, Lamborghini Super Trofeo North
America, and Mazda MX-5 Cup

**INTERNATIONAL SUPER
MODIFIED ASSOCIATION**

PO Box 5157
Oswego, NY 13126
ismasupers.com
REGION: Northeast & Canada
TYPE: Winged Super Modifieds

IRA OUTLAW SPRINTS

706 Green St.
McHenry, IL 60050
815-759-9269
irasprints.com
siraprez@sbcbglobal.net
REGION: IA, IL, IN, MN, WI
TYPE: 410 Winged Sprints, Wisconsin
Wingless Sprints

KAJUN MINI STOCKS ASSOCIATION

1209 Hwy. 35
Pelham, AL 35124
865-206-8307
john@kajunministocks.com
REGION: USA
TYPE: Modified Four-cylinder Stock Cars

KIDMODZ RACING SERIES

17047 N. 900 E.
Oakwood, IL 61858
618-314-3596
kidmodz.com
kidmodz@sbcbglobal.net
REGION: IL, MO
TYPE: Dirt Oval

KINGMAN ROUTE 66 STREET DRAGS

3880 Stockton Hill Rd., Ste. 103-428
Kingman, AZ 86409
530-521-4016
kingmanrt66streetdrags.com
REGION: AZ
TYPE: Drag Racing

LUCAS OIL AMERICAN SPRINT CAR SERIES (ASCS)

319 N. Bristow Ave.
PO Box 389
Drumright, OK 74030
918-838-3777
ascsracing.com
terry@ascsracing.com
REGION: AZ, IA, KS, LA, MO, OK, TX
TYPE: 360 Sprint Car Racing

LUCAS OIL LATE MODEL DIRT SERIES

299 Haskell Ln., Ut. C-6
Batavia, OH 45103
951-403-1609
lucasdirt.com
rick@lucasdirt.com

REGION: National
TYPE: Dirt Late Models

LUCAS OIL MIDWEST LATEMODEL RACING ASSN (MLRA)

18842 Speedway Dr.
PO Box 8
Wheatland, MO 65779
417-282-5984
mlraracing.com
ernie@lucasoil.com
REGION: MO
TYPE: Off-road, Drag Boat, Slip Track, Dirt Track

LUCKY DOG RACING SERIES

1155-C Arnold Dr., Ste. 365
Martinez, CA 94553
844-585-9364
racelucky.com
info@racelucky.com
REGION: USA
TYPE: North American Amateur Endurance Racing Series

MASTERS HISTORIC RACING

35A Market Pl.
Olney, Bucks MK46 4AJ
United Kingdom
347-475-6411
mastershistoricracing.com
team@mastershistoricracing.com
REGION: USA & Europe
TYPE: Historic Motor Racing

MID-WEST DRAG RACING SERIES

539-204-4740
midwestdragracingseries.com
keith@midwestpromodseries.com
REGION: AR, IL, KS, MI, MO, OK, TX
TYPE: Pro Mod Drag Racing

MIDWEST OPEN WHEEL ASSOCIATION

PO Box 584
Jacksonville, IL 62651
217-371-3653
midwestopenwheel.com
mowasprints@gmail.com
REGION: Midwest USA
TYPE: 410 Winged Sprint Cars



**Keep your Engine Track-Day Ready—
Detect Problems Early &
Avoid Major Failures!**

OilVue's oil analysis gives you information about:

- Oil Condition
- Wear Metals
- Contaminants

Get the most from your oil & safely extend time between oil changes.

Results sent to your mobile device!

Interested in protecting your engine?
Learn more about oil analysis:



OilVue.com

PIT TO PODIUM

PROFESSIONAL STRENGTH CORROSION INHIBITORS AND LUBRICANTS



KILLS CORROSION ON CONTACT

Stop by for a **FREE SAMPLE**
1oz ACF-50 OR CB LIQUID

PRI BOOTH# 1613

LEAR CHEMICAL RESEARCH CORPORATION
www.acf-50.com 1.800.256.2548

MIDWEST SPRINT CAR SERIES

9981 S. US Hwy. 41
Haubstadt, IN 47639
812-768-6025
mscssprints.com
ebutcher@sit-co.net

REGION: Midwest**TYPE:** Racing Sanctioning Body/Sprint Car Series**MIDWEST SUPER COMP SERIES**

11855 Cormoy Ln.
Orland Park, IL 60467
708-743-6150
midwestsupercomp.com
mwsc_rich@yahoo.com

REGION: IA, IL, IN, MI, WI**TYPE:** Super Comp Drag Racing**MIDWEST SUPERMODIFIED SERIES**

330-612-8963
midwestsupermodifieds.com
loriamay7@gmail.com

REGION: NY, OH, PA**TYPE:** Short Track-Supermodified Racing**MIDWESTERN COUNCIL OF SPORTS CAR CLUBS**

2410 Royal Ct.
Waukesha, WI 53188
262-442-6073
mcsc.org
president@mcsc.org

REGION: IA, IL, IN, MI, MN, WI**TYPE:** Sports Car Racing**MODIFIED RACING SERIES**

158 Potato Rd.
Canaan, NH 03253
603-707-0526
themodifiedracingseries.com
viperracing2@gmail.com

REGION: CT, ME, NH**TYPE:** Asphalt Small Block Modifieds**MONACO MODIFIED TRI-TRACK SERIES**

1098 Fall River Ave.
Seekonk, MA 02771
508-336-8307
monacomodifieds.com
info@monacomodifieds.com

REGION: CT, MA, NH, VT**TYPE:** Asphalt Modified Racing**MUST SEE RACING SPRINT SERIES**

11255 Glen Hill Ln.
Holly, MI 48442
248-762-1732
msrxtrreme.com
hmsinc98@aol.com

REGION: USA**TYPE:** Pavement Winged Sprints**NATIONAL ASSOCIATION FOR STOCK CAR AUTO RACING (NASCAR)**

One Daytona Blvd.
Daytona Beach, FL 32114
386-310-5492
nascar.com

REGION: USA, Canada, Mexico, Europe**TYPE:** Stock Car Racing**NATIONAL ASSOCIATION OF DIESEL MOTORSPORTS (NADM)**

919 NE 101st Terr.
Kansas City, MO 64155
816-810-6287
dieselmotorsports.us
ron@knochassoc.com

REGION: USA**TYPE:** Diesel Motorsports: Sled Pulling, Drag Racing, Dyno Competition, 4x4**NATIONAL AUTO SPORT ASSOCIATION (NASA)**

7065 W. Ann Rd., #130-432
Las Vegas, NV 89130
510-232-6272
nasaproracing.com

REGION: All USA**TYPE:** HPDE, NASA-X, Time Trial, Rally Sport, Road Racing**NATIONAL CHAMPIONSHIP RACING ASSOCIATION**

444 N. Oliver, #C1
Kechi, KS 67067
316-364-3093
racencra.com

REGION: KS**TYPE:** 360 Sprints, Late Models**NATIONAL ELECTRIC DRAG RACING ASSOCIATION**

207 Indian Warrior Trl.
Lake Jackson, TX 77566
979-665-5621
nedra.com
info@nedra.com

REGION: USA, Canada, Europe, Australia, New Zealand**TYPE:** Electric Vehicle Drag Racing**NATIONAL HOT ROD ASSOCIATION (NHRA)**

104 Via Verde, Ste. 100
San Dimas, CA 91773
626-914-4761
nhra.com

nhra@nhra.com**REGION:** USA**TYPE:** Championship Drag Racing**NATIONAL TRACTOR PULLERS ASSOCIATION (NTPA)**

6155-B Huntley Rd.
Columbus, OH 43229-1061
614-436-1761
ntpapull.com

gregg@ntpapull.com**REGION:** USA**TYPE:** Truck & Tractor Pulling**NITRO RALLYCROSS**

Thrill One Sports & Entertainment
946 W. 17th St.
Costa Mesa, CA 92627
nitrorallycross.com
info@thrillone.com

REGION: Canada, England, Finland, Saudi Arabia, Sweden, USA**TYPE:** Rallycross**NMCA MUSCLE CAR NATIONALS**

3518 W. Lake Center Dr., Ste. D
Santa Ana, CA 92704
714-444-2426
nmcadigital.com
office@promediapub.com

REGION: USA**TYPE:** Drag Racing**NMRA FORD NATIONALS**

3518 W. Lake Center Dr., Ste. D
Santa Ana, CA 92704
714-444-2426
nmradigital.com
office@promediapub.com

REGION: USA**TYPE:** Drag Racing**NORTH STATE MODIFIED SERIES**

6131 E. Hwy. 20
Lucerne, CA 95458
707-274-1662
northstatemodifieds.com
28arpy@mcchsi.com

REGION: CA**TYPE:** Modified Racing

NORTHEASTERN MIDGET ASSOCIATION (NEMA)

1273 Ringwood Ave.
Haskell, NJ 07420
nemaracing.com
timothy.bertrand@gmail.com
REGION: Northeast US
TYPE: Midget Racing

NORTHERN AUTO RACING CLUB (NARC)

4299 O'Connor Way
Sacramento, CA 95838
714-397-7417
narc410.com
info@narc410.com
REGION: CA
TYPE: Winged 410 Sprint Car Races

NORTHERN LATE MODEL RACING ASSOCIATION (NLRA)

2147 17th St. NE
Grand Forks, ND 58203
701-740-5201
nlra.org
REGION: MN, ND, SD, WI & MB, Canada
TYPE: Dirt Late Model Racing

NOSTALGIA DRAG RACING LEAGUE (NDRL)

480 Town Center Dr. N., #260
Mooreville, IN 46158
314-517-4455
nostalgiaadragleague.com
REGION: USA
TYPE: Pro 7.0, Pro 7.50, Pro Comp and Pro Gas

NOSTALGIA SUPER STOCK

262-844-2111
nostalgiasuperstock.com
rberlisk@wi.rr.com
REGION: USA
TYPE: Drag Racing Super Stock Cars of the 1960s

OIL CAPITAL RACING SERIES

412 E. 6th St.
Caney, KS 67333
620-330-0485
ocsracing.net
terry@ascsracing.com
REGION: KS, MO, OK, TX
TYPE: Sprint Car Racing

OUTLAW DIESEL SUPER SERIES

4960 N. 13th St.
Terre Haute, IN 47805
812-241-8541
outlawdieselss.com
REGION: USA
TYPE: Diesel Drag Racing, Diesel Pulling

OUTLAW STREET CAR ASSOCIATION

8071 Tillman Bethel Rd.
Henderson, KY 42420
270-452-9085
outlawstreetcars.com
oscaseries@gmail.com
REGION: IL, IN, KS, KY, TN, VA, WV
TYPE: Drag Racing

OUTLAW TRUCK & TRACTOR PULLING ASSOCIATION

745 Riverview Dr.
Rock Valley, IA 51247
712-470-1593
outlawpulling.com
contact@outlawpulling.com
REGION: USA
TYPE: Outlaw Truck and Tractor Pulling

PRECISION WINS THE RACE
VISIT US AT PRI BOOTH # 4406

BOKER'S, INC.
PRECISION SHIMS, WASHERS & STAMPINGS—SINCE 1919
(800)-WASHERS bokers.com

KINSLER
We did the Lucas metering for the Can-Am: 60's thru 70's; still do. Any injection: Road race, Sprint cars, Boats, Indy 500, NASCAR Cup, Drags, Motorcycles, Bonneville, Pullers, Street, etc. EFI, Constant Flow, Lucas Mechanical

Action Express Cadillac, '14, '15, '16, '17 IMSA Champs, '18, '21 Won driver & Mfr. Champs, overall '20 Daytona 24 Hrs

See us at PRI Booth #1406

Householder Motorsports

Trick Truck Won "2020 Laughlin" with Patton Race Engine. Uses Kinsler's 4500 throttle body with Drive By Wire.

Kinsler GT Porsche ITBs. We partnered with Ed Pink Racing Engines to design "Direct To Head" ITB package.

Monster Mesh Filter

EFI Injectors, all makes of Pressure Relief Valves and Lucas Mechanical Metering Units, and need 3 micron protection, but 3 micron filters plug up too quickly, so most racers use 10 micron, which is too coarse. We made this new element for NASCAR Cup cars: 10 micron premium paper top layer to take out 95% of the dirt, with a 3 micron precision Fiberglass lower layer. Details: Kinsler.com home page.

K-140 Pressure Relief Valve
Used on 95% of NASCAR Cup and INDY 500 cars

10/3 Element

(248)362-1145 Troy, Michigan USA sales@kinsler.com

OZARK MOUNTAIN SUPER SHIFTERS

118 Hollis St.
Kewanee, IL 61443
309-853-2626
ozarkmountainsupershifters.com
jlclabough91@gmail.com
REGION: Midwest
TYPE: Drag Racing

PATRIOT SPRINT TOUR

315-483-2296
patriotsprinttour.com
mikeemhof@patriotsprinttour.com
REGION: NY, PA & ON, Canada
TYPE: Winged Sprint Car Racing

PORSCHE CLUB OF AMERICA

PO Box 6400
Columbia, MD 21045
410-381-0911
pca.org
admin@pca.org
REGION: USA, Canada
TYPE: Car Club

PORSCHE OWNERS CLUB

1968 S. Coast Hwy., #4911
Laguna Beach, CA 92651
619-630-0673
porscheclub.com
REGION: CA
TYPE: Car Club

POWRI RACING INC

8939 Bevo Ct.
Belleville, IL 62223
314-267-4944
powri.com
kbrown@powri.com
REGION: USA
TYPE: Open Wheel, National Midgets, Micros, Sprints

PREMIER STREET CAR ASSOCIATION

45423 6th St.
Lancaster, CA 93535
661-917-3078
racepsca.com
mel@racepsca.com
REGION: CO
TYPE: PSCA Heads-up, Index & Bracket Racing, Vegas Show Series, Vendors Midway

PRO ALL STARS SERIES (PASS)

195 Lakehouse Rd.
Naples, ME 04055
207-693-6497

proallstarseries.com
passracing@roadrunner.com
REGION: CT, MA, ME, NH, VT
TYPE: National Super Late Models, North Super Late Models, New England Supermodified Series, and PASS Modifieds

PROFESSIONAL DRAG RACERS ASSOCIATION (PDRA)

PO Box 1578
Pittsboro, NC 27312
731-345-9058
pdra660.com
tyler@pdra660.com
REGION: USA, Canada, Sweden, Australia, Qatar, and Bahrain
TYPE: Drag Racing

QUARTER MIDGETS OF AMERICA (QMA)

31444 54th Ave. S.
Auburn, WA 98001
918-371-9519
quartermidgets.org
secretary@quartermidgets.org
REGION: USA, Canada
TYPE: Midget Racing

RACESAVER SPRINT SERIES

PO Box 17
Bennington, NE 68007
402-238-2595
racesaver.com
slackerinvest@hotmail.com
REGION: USA
TYPE: Sprint Cars

RUSH RACING SERIES

4368 US 422
Pulaski, PA 16143
724-964-9300
rushracingseries.com
info@rushracingseries.com
REGION: CT, MA, ME, NH, NY, RI, VT & Canada
TYPE: Stock Cars and Modifieds

SCORE INTERNATIONAL

9434 Bond Ave.
El Cajon, CA 92021
775-852-8907
score-international.com
registration@score-international.com
REGION: USA & Mexico
TYPE: Off-Road Racing, Desert Racing

SOUTHERN ALL STAR DIRT RACING SERIES

132 Jetplex Ln.
Madison, AL 35758
256-924-4546
sasdirt.com
matt.wagner@sasdirt.com
REGION: AL, FL, GA, MS, NC, SC, TN
TYPE: Dirt Late Model

SOUTHERN CALIFORNIA TIMING ASSOC & BONNEVILLE NATIONALS

PO Box 10
Orosi, CA 93647
559-528-6279
scta-bni.org
office@scta-bni.org
REGION: CA, UT
TYPE: Land Speed Racing

SOUTHERN NEVADA OFF ROAD ENTHUSIASTS (SNORE)

4780 W. Ann Rd., Ste. 5452
North Las Vegas, NV 89031
702-292-9491
snoreracing.net
info@snoreracing.net
REGION: NV
TYPE: Off-Road

SOVREN

17806 Bass Ln. NW
Lakebay, WA 98349
360-329-2513
sovrenracing.org
REGION: Pacific Northwest
TYPE: Vintage Racing

SPEARS (SRL) SOUTHWEST TOUR SERIES

PO Box 6217
Bakersfield, CA 93386
661-679-4681
srlsouthwesttour.com
REGION: Southwest
TYPE: Pavement Late Model Racing, Pavement Modified Racing

SPEED ENERGY STADIUM SUPER TRUCKS

10615 Twin Lakes Pkwy.
Charlotte, NC 28269
704-949-1255
stadiumsupertrucks.com
info@stadiumsupertrucks.com
REGION: USA, Australia, New Zealand, China
TYPE: Off-road Truck Racing

SPORT COMPACT DIRT RACING ASSOCIATION

6 Birch St.
Woodruff, SC 29388
864-871-1442
scdra.net
kelcarms@gmail.com
REGION: AL, FL, GA, KY, NC, OH, SC
TYPE: Sport Compact Dirt Racing

SPORTS CAR CLUB OF AMERICA (SCCA)

6620 SE Dwight St.
Topeka, KS 66619
785-357-7222
scca.com
insideline@scca.com
REGION: USA
TYPE: Road Racing, Auto Cross

SPORTSCAR VINTAGE RACING ASSOCIATION (SVRA)

1312 Regency Ct.
Southlake, TX 76092
888-965-7872

svra.com
kathy@svra.com
REGION: CA, CT, FL, GA, IN, NC, NJ, NY, OH, OR, TN, TX, UT, WA, WI
TYPE: Vintage Sports Car Racing

SRO MOTORSPORTS GROUP AMERICA

PO Box 633
Arlington, NE 68002
531-444-8558
world-challenge.com
REGION: CA, FL, IN, LA, TX, VA, WI
TYPE: Road Racing

STARS CHAMPIONSHIP SERIES

PO Box 2166
Noblesville, IN 46061
317-774-7021
starschampionshipseries.com
info@starschampionshipseries.com
REGION: IN, OH, PA
TYPE: Karting

STOCK CAR RACE SERIES

PO Box 4432

Paso Robles, CA 93447
805-227-4409
stockcarraceseries.com
info@stockcarraceseries.com
REGION: CA
TYPE: Vintage Stock Car Racing

SUMMIT RACING MIDWEST DRAGS

PO Box 155
Westfield, IN 46268
317-299-7223
summitmidwestdrags.com
heid@proqmotorsports.com
REGION: IN, KY, OH
TYPE: Drag-N-Drive

SUNOCO AMERICAN LATE MODEL SERIES

PO Box 411
Grayville, IL 62844
618-450-2072
americanlatemodelseries.com
sdriggers@dirtcar.com
REGION: IL, IN, MI
TYPE: Late Model Racing

Bank on Aurora

Aurora Spherical Bearings and Rod Ends are made in the USA to the highest quality standards so you can take on the toughest turns with confidence.

Aurora's quality systems are Registered and Certified to ISO9001 & AS9100.

AURORA

P 630.859.2030 www.aurorabearing.com

Raybestos POWERTRAIN

40

SPEED PERFORMANCE

DEDICATED TO INNOVATION FOR OVER 120 YEARS.

We've been committed to engineering excellence since the beginning of the automotive industry. Today we are proud to bring innovative GPZ friction clutch material to the Ford and GM 10-Speed platforms of the future. Find GPZ test data at: RaybestosPowertrain.com/gpz

MADE IN USA RaybestosPowertrain RaybestosPowertrain
1.800.686.4729 RaybestosPowertrain.com

Gearbox

SUPER CUP STOCK CAR SERIES LLC

167 New Rockwood Rd.
Arden, NC 28704
828-768-3589
supercupstockcarseries.com
jschmaling@supercupstockcarseries.com
REGION: OH, PA, TN, VA
TYPE: Full-size American Stock Cars

SUPER DIRT CAR SERIES

7575-D W. Winds Blvd.
Concord, NC 28027
704-795-7223
superdirtcarseries.com
info@dirtcar.com
REGION: FL, NC, NY, PA, VT & Canada
TYPE: Big Block Modified Racing

SUPERKARTS! USA (SKUSA)

33175 Temecula Pkwy., Ste. 233
Temecula, CA 92592
951-491-0808
superkartsusa.com
info@superkartsusa.com
REGION: USA, Canada
TYPE: Shifter Kart Racing

TEXAS DIRT TRUCK SERIES

210-449-4506
texasdirtruckseries@gmail.com
REGION: TX
TYPE: Dirt Truck Racing

TEZOS ALL STAR CIRCUIT OF CHAMPIONS (ASCOC)

438 Southpoint Cir.
Brownsburg, IN 46112
317-299-6066
allstarsprint.com
allstars@tonystewart.com
REGION: FL, GA, MI, MO, NY, OH, PA, WI
TYPE: Winged Sprint Car Racing

TOP GUN SPRINT SERIES

6333 Burts Rd.
Tampa, FL 33619
813-677-7326
topgunsprints.com
annrehm43@gmail.com
REGION: Florida
TYPE: Winged Dirt Sprint Car Racing

ULTIMATE OUTLAW SHOOTOUT SERIES

PO Box 55
Libertytown, MD 21762
301-938-1506
ultimateoutlaws.com

pbracing1@gmail.com
REGION: MD, MI, NC
TYPE: Drag Racing

ULTRA4 RACING

35820 Galena Circle
Temecula, CA 92592
909-273-0216
ultra4racing.com
dave@ultra4racing.com
REGION: USA, Mexico, Europe, China
TYPE: Off-Road and King of the Hammers

UNITED REBEL SPRINT SERIES

900 W. Victoria St., #15
Oberlin, KS 67749
785-475-7010
unitedrebelsprintseries.com
rksalem@eaglecom.net
REGION: CO, KS, UT
TYPE: Sprint Series

UNITED SPRINT CAR SERIES

175 Antebellum Way
Fayetteville, GA 30215
770-865-6097
uscsrcing.com
peteuscs@att.net
REGION: AL, AR, FL, GA, LA, MS, SC, TN
TYPE: Sprint Car Racing

UNITED STATES ASSOCIATION OF PULLERS

2974 Tibbs Rd.
Brownsville, TN 38012
731-445-2492
usapullers.org
REGION: USA
TYPE: Truck and Tractor Pulling

UNITED STATES AUTO CLUB (USAC)

4910 W. 16th St.
Speedway, IN 46224
317-247-5151
usacracing.com
kirk@usacracing.com
REGION: USA
TYPE: Silver Crown, Sprint Car, Midget, Ignite, 25 Next Gen, Off-Road, Rally

UNITED STATES MODIFIED TOURING SERIES

PO Box 905
Webster City, IA 50595-0905
515-832-7944
usmts.com
REGION: USA
TYPE: Dirt Modified

UNITED STATES RACING ASSOCIATION

PO Box 905
Webster City, IA 50595-0905
515-832-6000
usraracing.com
REGION: AR, AZ, IA, KS, MN, MO, MS, ND, NE, NM, OK, SD, TX, WI
TYPE: Modified Stock Cars, Late Model, Sprint Cars, B-Mods, Hobby

UNITED STATES SPEED ASSOCIATION

2685 S. 25th W.
Lebanon, IN 46052
317-413-9763
ussaracing.com
info@ussaracing.com
REGION: USA, Australia, New Zealand
TYPE: Kenyon Midget Races

UNITED STATES TOURING CAR CHAMPIONSHIP (USTCC)

PO Box 2008
Napa, CA 94558
707-643-1000
ustcc.com
ali@ustcc.com
REGION: CA, NJ, PA, WV
TYPE: Road Racing

UPPER MIDWEST SPRINT CAR SERIES

2700 420th St. W.
Harris, MN 55032
612-363-5302
umsprints.com
ron@umsprints.com
REGION: IA, MN, WI
TYPE: Sprint Car Racing

US LEGEND CARS INTERNATIONAL

5245 Hwy. 49 S.
Harrisburg, NC 28075-8476
704-455-3896
uslegendcars.com
agarrett@uslegendcars.com
REGION: USA, Canada, Mexico, Central America, South America, Europe, Middle East, Africa, Asia, Australia, New Zealand
TYPE: Legends, Bandoleros

VINTAGE AUTO RACING ASSOCIATION (VARA)

4195 Chino Hills Pkwy., #457
Chino Hills, CA 91709
800-280-8272
vararacing.com
vara@msn.com
REGION: CA, NV
TYPE: Pre-war Historics, All Vintage Race Cars Up to 1989

WILROC SPRINT CAR & SUPERMODIFIED RACING

wilrocracing.com
sherriconway@hotmail.com
REGION: Canada
TYPE: Supermodified & Sprint Car

WISSOTA PROMOTERS ASSOCIATION

2700 1st St. N., Ste. 209
Saint Cloud, MN 56303
320-251-1360
wissota.org
REGION: MN, MT, ND, SD, WI, WY & Canada
TYPE: Late Model, Modified, Super Stock, Midwest Mod, Street Stock, Pure Stocks, Hornets, Mod Four

WORLD DRAG RACING ALLIANCE (WDRA)

Springfield, IL
racewdra.com
REGION: AR, DE, FL, IA, IL, IN, KY, LA, MD, MI, MO, MS, MT, NC, NY, PA, SC, TN, TX & Canada
TYPE: Drag Racing

WORLD EXTREME ROCK CRAWLING

51 N. Broadway, #142
Blackfoot, ID 83221
530-417-5333
werocklive.com
REGION: USA
TYPE: Off-road, Event Promoter, 4Low Magazine

WORLD KARTING ASSOCIATION

6051 Victory Ln.
Concord, NC 28027
704-455-1606
worldkarting.com
info@worldkarting.com
REGION: USA
TYPE: Kart Racing

WORLD RACING GROUP

7575-D Westwinds Blvd.
Concord, NC 28027
704-795-7223
worldracinggroup.com
info@dirtrcar.com
REGION: USA

TYPE: DIRTcar Racing, World of Outlaws, Xtreme Outlaw Series

WORLD RACING LEAGUE

4134 Jersey Pike
Chattanooga, TN 37421
731-217-6093
racewrl.com
race@racewrl.com
REGION: USA
TYPE: Road Racing

WSK PROMOTION SRL

Plaza della Repubblica, 8
73024 Maglie, Lecce
Italy
+39-836-427550
wskarting.it
info@wskarting.com
REGION: International
TYPE: Kart Racing

MOTIVE COMPONENTS LTD
THE Engine Experts Since 1981.
Over 40yrs experience in the automotive industry

Come see us
STAND #3308
DECEMBER 8-10, 2022
INDIANAPOLIS, INDIANA, USA

Supplying the Highest Quality
ENGINE COMPONENTS
From Materials Rigorously Tested and Approved in the UK

RANGE **QUALITY** **DISTRIBUTION**

PERFORMANCE PRODUCTS FOR DIESEL TRACTOR & PICK-UP TRUCK PULLING MACHINES

HYPERMAX DIESEL FUEL INJECTION
*In-Line Mechanical Injection Pumps
*Common Rail Injection Systems for
*6.7L Ford & 7.3L Navistar Engines

FORD DIESEL PERFORMANCE
*PICK-UPS, VANS, EXCURSIONS
*ENGINE COMPONENTS
*EXHAUST SYSTEMS
*INJECTORS
*INTERCOOLERS
*TURBOCHARGERS
*ELECTRONICS

"BONE TWISTER"

TURBO SYSTEMS **"BULLET PROOF"** **"HIGH FLOW"** **INJECTION SYSTEMS**
4 Bolt Main IH Block 4 Bolt Main IH Block shown with 4 bolt main IH block

MANIFOLDS **CYLINDER SEALING**

7.3L IN-LINE FUEL INJECTION PUMP ENGINE **VALVE TRAIN COMPONENTS** **ENGINE COMPONENTS**
Common Rail System also available

DIESEL POWER **Hypermax ENGINEERING**

HYPERMAX DIESEL DRAGSTER
HYPERMAX/IH DT 466 TRIPLE TURBOCHARGER
3,600 LB. NHRDA TOP DIESEL DRAGSTER
216.27 MPH/6.69 E.T.

255 EAST ROUTE 72 GILBERTS, ILLINOIS 60136
847-428-5655 + **GOHYPERMAX.COM**



SECTION

7

MANUFACTURERS' REPRESENTATIVES

An invaluable link between suppliers and the customers who move their products, manufacturers' representatives interact with everyone from the largest warehouse distributors to the smallest speed shops and engine builders. They typically act as a supplier's outside sales force. Many also work trade shows and/or car shows for their clients, while others manage their customers' wholesale operations.

10K SALES & MARKETING INC

623 Nightingale Blvd.
Stillwater, MN 55082
651-238-5788

TERRITORY: MN, ND, SD, WI

LINES: Howard Industries, HR Performance, ITM, Midwest Acorn Nut, Valco Cincinnati

AIRHEART SALES

13805 409th Ave. SE
North Bend, WA 98045
425-888-2540
airheartsales.com

TERRITORY: AK, AZ, CA, CO, HI, ID, MT, NM, NV, OR, UT, WA, WY & Canada

LINES: ACL, Be Cool, Cometic, Howard's, Klotz Racing Oil, Magnecor, Prothane, Race Winning Brands, Schumann's Oil Pumps, ThermoTec, Total Seal

ALL-MIDWEST SALES, LLC

2111 Lanterman Circle
Hinckley, OH 44233
216-225-4564
allmidwestsales.com

TERRITORY: AL, AR, CO, FL, GA, IA, IL, IN, KY, KS, LA, MI, MN, MO, MS, NC, ND, OH, OK, SC, SD, TN, TX, VA, WI, WV

LINES: Aeromotive, Airsept, Alltrade/Powerbuilt Tools, ANZO USA, The Bracketeer, Champion Brands, Design Engineering Inc., Dynamat, EZ 4x4, FK Bearings, Fragola Performance Systems, FST Performance, Howards Cams & Racing Components, Jet Performance Products, Made For You Products, LLC, Maradyne, Notthead, Ohio Brush Works, Performance Automatic, PerTronix LLC, Porter Muffler, Powermaster Performance, Pro/Race Performance Products, Quik-Latch Products, Shaviv USA, VDO (Continental Automotive), XS Power Batteries

AMERICAN SALES & MARKETING

825 College Blvd., Ste. 102-315
Oceanside, CA 92057
760-726-8226
asmwp.com

TERRITORY: USA: Account Specific/Military Exchange System

LINES: Firestone, Horizon Tire, The Hoffman Group, K Tool International/Ford Tools, K1 Race Gear, Kafko International, Kookaburra Liquorice, Kyowa Racing Wheels, NTP Stag, Pentius Filters, Phoenix Systems, Razor USA, Rightline Gear, SATCO Products, Shurhold Industries, Tonkin Parts Center, Torin Inc., Van Leeuwen Distributing, WeatherTech, World and Main (HBC Home & Hardware), XS Power Batteries

APPLIED COMPONENTS

5077 Waterford Dr., Ste. 306
Sheffield Village, OH 44035
440-934-9595
aci-sales.com

TERRITORY: East Coast & ON, Canada

LINES: AL Hansen, BEI Duncan, Crouzet, Delphi Diesel Systems, Hamsar Diversco, Jet Fabricators, Kavlico, MTE Hydraulics, Nason Company, OEM Fabricators, Voisard Manufacturing, R&R Engineering, VDO (Continental)

ATZENHOFFER SALES & MARKETING (ASM)

9597 Jones Rd., Box 151
Houston, TX 77065
713-849-1984

TERRITORY: AR, KS, LA, MO, OK, TX

AUTOMOTIVE AFTERMARKET REPS

516-794-7770
TERRITORY: USA

AUTOREP SALES CO INC

725 S. Adams Rd., Ste. L-145
Birmingham, MI 48009
248-792-5442
autorepsales.com

TERRITORY: IL, IN, KY, MI, OH, Western PA, WI, WV

BALLARD & ALLEN MARKETING

3641 Bates St.
Irvine, CA 92614
949-722-7716
ballardallen.com

TERRITORY: USA

BC SALES & MARKETING INC

91 Marlyn Dr.
Newark, OH 43055-9509
740-366-2872

TERRITORY: IN, KY, MI, OH

LINES: Flaming River Industries, Power Stop, Ratech

BOB COOK SALES

9245 Poplar Ave., Ste. 5 #129
Germantown, TN 38138
901-854-4632
bobcooksales.com

TERRITORY: USA

CHRIS KOURI & ASSOCIATES

1200 N. Jefferson St., Ut. K
Anaheim, CA 92807
714-630-2311
chriskouri.com

TERRITORY: AK, AZ, CA, HI, ID, NV, OR, WA

DEVEREAUX JONES COMPANY LLC

1355 Canadaville Loop
Eads, TN 38028
901-317-6937

TERRITORY: USA

LINES: Internal Engines, Towing Products, Brakes Products, Chemicals, HP Starters & Alternators

DON GROSS SALES

1951 E. 48th St.
Vernon, CA 90058
323-582-3450
dongross.com

TERRITORY: Southern California, Baja California

LINES: Durabond, Melling, Safety Auto, SB International, Silver Seal, UEM Pistons, US Tool

EPJ ASSOCIATES INC

PO Box 399
Glenside, PA 19038-0399
267-234-1798
epj-inc.com

TERRITORY: USA and Northeast

LINES: American Cylinder Head (USA), CCCN (USA), CVR (Northeast), QualCast (Northeast)

FOSTER BABCOCK & ASSOCIATES

313 Delaware St.
Kansas City, MO 64105
816-283-3355
fosterbabcock.com

TERRITORY: IA, IL, KS, MN, MO, ND, NE, SD, WI

LINES: US Auto Parts and VSI (Hammond, IL)

HARRY MILLER SALES

162 Doug Allison Heights
Cleveland, GA 30528
706-809-9145
harrymillersales.com

TERRITORY: USA

LINES: ATM Innovation, Cometic Gasket, King Engine Bearings, Klotz Synthetic Lubricants, Larson Racing, Pimp Juice, TI Automotive/Walbro, Valco Cincinnati CP

JAMISON EQUIPMENT INC

1908 11th St.
Emmetsburg, IA 50536
800-841-5405
jamisonequipment.com

TERRITORY: USA

LINES: ABS Products, AXE Equipment, BHJ Products, Hines Industries, Saenz Performance USA, Turner Technology

JIM KERR & ASSOCIATES LLC

45 Carriage House Dr.
Holland, PA 18966-2224
215-355-3613
jimkerr.com

TERRITORY: DE, MD, NJ, NY, PA, VA (Fairfax County)

LINES: Busch, Moroso, Made 4 You, McGard, Royal Purple

JIM WROBLESKI & CO INC

2146 N. Karwick Rd., Ste. A
Michigan City, IN 46360-7381
219-879-8145
jwcreps.com

TERRITORY: USA

KAM MARKETING

411 Old Baltimore Pike, Ste. 101
Chadds Ford, PA 19317
302-658-7778
kammarketing.com

TERRITORY: CT, DE, IL, IN, KY, MA, MD, ME, MI, NC, NJ, NY, OH, PA, RI, TN, VA, VT, WI, WV & Eastern Canada

LINES: Eaton, Energy Suspension, KW Automotive, Magnaflow, Milodon, Northern Factory Radiator, Permatex, Powermaster

KUNZMAN & ASSOCIATES

4094 Pioneer Dr.
Walled Lake, MI 48390-1351
248-360-2700
kunzman.com

TERRITORY: USA

LINES: AeroQuip, ARP, Bestop, FiTech, Hedman Heddors, QA1, Scat, Westin

MACK EQUIPMENT SALES

4224 Lassek Ct.
Eau Claire, WI 54703
715-832-3282
mackequipmentsales.com

TERRITORY: USA

LINES: Axe Equipment, LS Industries, Rottler

MC SALES & MARKETING

15581 Computer Ln.
Huntington Beach, CA 92649
714-901-8589
mcsalesmarketing.com

TERRITORY: USA

OWEN EQUIPMENT SALES

84 Andrea Dr.
Richboro, PA 18954-1302
215-322-7344

TERRITORY: DE, MD, NJ, PA

LINES: Delta Custom Tools, Irontite by Kwik-Way, RMC Engine Rebuilding Equipment, Silver Seal Products Co., Inc. Sunnen Products Company

PROREP MARKETING

14 Meade Ln.
Enfield, CT 06082
860-767-0024
prorepmarketing.com

TERRITORY: DC, DE, MD, NJ, NY, PA, New England & Canada

LINES: Aeromotive, ARP, AutoMeter, EGR, Flex-A-Lite Consolidated, Motive Gear, Painless Performance Products

R & R MARKETING CONSULTANTS, INC

PO Box 481381
Kansas City, MO 64148
650-588-3404
rrmci.com

TERRITORY: USA

LINES: Aeromotive, Canton Racing Products, COMP Cams, Derive Systems (SCT, Bully Dog, Derive Efficiency), Driven Racing Oil, Edelbrock, Energy Suspension, Evans Cooling Systems, Grant Products, Hastings Manufacturing Company, King Engine Bearings, Lunati, MAHLE Motorsports, Painless Performance Products, Revtek Industries, TCI Automotive, US Gear, ZEX

REPFORCE

210 Turner Industrial Way
Aston, PA 19014
610-485-7800
repforce.com

TERRITORY: USA

LINES: Accel Performance/Mr. Gasket, Airaid, Bosch Service Solutions, Derale, FIA, Hedman, Pioneer Performance, Vision X

REPWORKS MARKETING LLC

1745 S. Alma School Rd., Ste. 260
Mesa, AZ 85210-3013
602-279-1987
repworksmktg.com

TERRITORY: AK, AZ, CA, HI, NV, OR, WA & AB, BC, Canada

LINES: Bosch Gauges, Surco

RT SALES

1625 N. Milford Rd.
Highland, MI 48357-0624
248-887-0422
rtsalesinc.com

TERRITORY: USA

LINES: Serdi Corporation, Sunnen Products Company

SAWATZKY SHOP EQUIPMENT

3704 E. Cove Park Trl.
Hernando, FL 34442-5520
352-419-6935

TERRITORY: USA

LINES: Baker Equipment, Interchem, Peterson Machine Tool

SCOTT LEWIS ASSOCIATES INC.

994 Northern Blvd.
Baldwin, NY 11510
877-415-4422
scottlewisinc.com

TERRITORY: AL, AR, AZ, CA, CO, CT, DC, DE, FL, GA, IA, ID, IL, KS, KY, LA, MA, MD, ME, MI, MN, MO, MS, MT, NC, ND, NE, NH, NJ, NM, NV, NY, OH, OK, OR, PA, PR, RI, SC, TN, TX UT, VA, WI, WV, Eastern Canada, Western Canada

LINES: Berryman, Comet Gaskets, CP Pistons, Daido Engine Bearings, Davies Craig, Exedy, G3, Golight, Global Parts, Howards Cams, Meyer Plows, Milemarker, Neapco, Redarc, Rollmaster, Romac, Speedflow, Turbosmart, Westcan

SEBRC

3630 Valley Oak Dr.
Loveland, CO 80538
303-888-0957

TERRITORY: USA**SHERMAN PEARSON COMPANY**

26309 Miles Rd.
Cleveland, OH 44128-5997
216-464-3094
shermanpearson.com

TERRITORY: IN, KY, MI, NY, OH, PA, WV

**SOUTHWEST MOTORSPORTS
MARKETING**

4228 Hockaday Dr.
Dallas, TX 75229

TERRITORY: AR, LA, OK, TX

LINES: Energy Suspension, Hypertech, K&N Engineering, Suspension Techniques

THE KAYES CO INC

643 Bear Run Ln.
Lewis Center, OH 43035-7133
614-481-8811
thekayesco.com

TERRITORY: USA

LINES: Heartthrob Exhaust

THE SHOP DOC

15550 Linnet St. NW, Apt. 301
Andover, MN 55304
763-464-1286

TERRITORY: USA

LINES: Consulting for engine rebuilders, shop layout, workflow, work processes, and equipment purchasing

UHLE & CLARK INC

1452 Turkey Trot Rd.
Warwick, PA 18974
215-588-0067
uhleclark.com

TERRITORY: USA

LINES: Dura-Bond Bearing Co., Lucas Oil Products, Melling Performance

WOODWARD EQUIPMENT

15790 SE Piazza Ave., Ste. 104
Clackamas, OR 97015-9141
503-657-6680
woodwardequipment.com

TERRITORY: USA

LINES: AXE Equipment, BHI Products Inc., Delta Custom Tools, Hines Industries, Inc., Irontite by Kwik-Way, Neway Manufacturing, Silver Seal Products Co., Van Norman, Zero Error Racing



SECTION

8

WAREHOUSE DISTRIBUTORS

These operations bridge the gap between motorsports industry suppliers and the retail businesses that deal directly with racers and team members. Among their myriad functions, warehouse distributors (WDs) provide valuable storage space, communication tools, technical support, cataloging, and other useful services. Several also work within an established marketplace, giving them unique insight into the parts and equipment in demand for a specific region.

ALLPRO DISTRIBUTING

43 Airpark
Alabaster, AL 35007
800-858-4487
customercare@allprodistributing.net
allprodistributing.net

ATECH MOTORSPORTS

1200 Southeast Ave.
Tallmadge, OH 44278
800-517-1040
customerservice@atechmotorsports.com
atechmotorsports.com

BEHRENT'S PERFORMANCE WAREHOUSE

38 Meadow Rd.
Florida, NY 10921
845-651-7389
behrents.com

BOLTSANDNUTS.COM

3705 Lane Rd. Ext.
Perry, OH 44081
440-606-6557
info@boltsandnuts.com
boltsandnuts.com

COMPETITION PRODUCTS

280 W. 35th Ave.
Oshkosh, WI 54902
800-233-0199
info@competitionproducts.com
competitionproducts.com

DAY MOTOR SPORTS

6100 US Hwy. 69 N.
Tyler, TX 75706
800-543-6238
daymotorsports.com

**ENGINE AND PERFORMANCE
WAREHOUSE**

955 Decatur St., Ut. D
Denver, CO 80204
303-572-8844
epwi.net

ENGINE PRO (ENGINE PARTS GROUP)

4891 Independence St., Ste. 205
Wheat Ridge, CO 80033
800-ENGINE-1
303-424-3200
enginepro@enginepro.com
enginepro.com

JEGS HIGH PERFORMANCE

101 Jegs Pl.
Delaware, OH 43015
800-345-4545
jegs.com

JOBBER'S WAREHOUSE SUPPLY

800 Third Ave. N.
Minneapolis, MN 55405-1606
800-489-4520
612-377-4520
info@enginepartsp.com
enginepartsp.com

JOHNSTON RESEARCH & PERFORMANCE

2344 S. Sheridan Way
Mississauga, ON L5J 2M4
CANADA
905-822-7223
jrponline.com

KEYSTONE AUTOMOTIVE OPERATIONS

44 Tunkhannock Ave.
Exeter, PA 18643
800-521-9999
customercare@keystone.com
keystoneautomotive.com

MEYER DISTRIBUTING

560 E. 25th St.
Jasper, IN 47546
800-MEYER-USA
meyerdistributing.com

MOSS MOTORS LTD.

440 Rutherford St.
Goleta, CA 93117
800-667-7872
805-681-3400
moss.sales@mossmotors.com
mossmotors.com

MOTOR STATE DISTRIBUTING

8300 Lane Dr.
Watervliet, MI 49098
800-772-2678
269-463-4113
info@motorstate.com
motorstate.com

NATIONAL PERFORMANCE WAREHOUSE

11150 NW 32nd Ave.
Miami, FL 33167
800-344-0368
npwcompanies.com

NICKELS PERFORMANCE

293 Industrial Park Rd.
Piney Flats, TN 37686
800-251-0331
nickels-performance.com

**PREMIER PERFORMANCE PRODUCTS
DISTRIBUTION**

278 E. Dividend Dr.
Rexburg, ID 83440
888-497-3666
208-356-0106
premierwd.com

SCOGGIN DICKEY PARTS CENTER

5901 Spur 327
Lubbock, TX 79424
800-456-0211
sdparts.com

SPEED AND ENGINE WAREHOUSE

2001 E. 19th St.
Tucson, AZ 85719
800-365-4292
520-792-1830
speedandengine.com

SPEEDWAY MOTORS

340 Victory Ln.
Lincoln, NE 68528
855-313-9181
speedwaymotors.com

TORQUED DISTRIBUTION

121 S. Maple Ave., Ste. 4
South San Francisco, CA 94080
415-767-6905
help@torqueddistribution.com
torqueddistribution.com

TURN 14 DISTRIBUTION

100 Tournament Dr.
Horsham, PA 19044
877-7TURN14
267-468-0350
general@turn14.com
turn14.com

XTREME DIESEL PERFORMANCE

1758 State Route 34 N.
Wall Township, NJ 07727
888-DIESEL-4
732-719-0955
xtremediesel.com

A1 CYCLES

4336 S. NC 16 Hwy.
Maiden, NC 28650
561-603-6671

draindaddie.com

Category: MACHINERY, TOOLS & EQUIPMENT

Entry on Page 124

ABS PRODUCTS

591 W. Apollo St.
Brea, CA 92821
714-671-0728

abs-products.com

Category: MACHINERY, TOOLS & EQUIPMENT

Entry on Page 124

ACCELO RACEWEAR

1835 N. Enterline Rd.
Punxsutawney, PA 15767
510-990-0099

acceloracewear.com

Category: RACING COMPONENTS,
ACCESSORIES & SERVICES

Entry on Page 86

ACCU-FORCE DYNOS & TESTERS

7358 Country Rd. 623
Millersburg, OH 44654
330-674-2847

accuforcetesters.com

Category: MACHINERY, TOOLS & EQUIPMENT

Entry on Page 126

ADVANCED FUEL DYNAMICS

12843 Vaughn Rd.
Troy, TX 76579

866-902-3835

advancedfueldynamics.com

Category: RACING COMPONENTS,
ACCESSORIES & SERVICES

Entry on Page 86

ADVANTAGE LIFTS

33 Amy Way
Hanover, PA 17331

763-300-5730

advantagelifts.com

Category: MACHINERY, TOOLS & EQUIPMENT

Entry on Page 126; **Ad on Page 61**

AED METAL PRODUCTS & SUPPLIES

5373 W. 86th St.
Indianapolis, IN 46268

317-334-0569

aedmetalproducts.com

Category: RACING COMPONENTS,
ACCESSORIES & SERVICES

Entry on Page 86

AERO EXHAUST

3928 Oregon St.
Benicia, CA 94510
801-301-0408

aeroexhaust.com

Category: ENGINE COMPONENTS

Entry on Page 18

AEROMOTIVE INC.

11414 W. 79th
Lenexa, KS 66214
913-647-7300

aeromotiveinc.com

Category: ENGINE COMPONENTS

Entry on Page 18

AIR TURBINE TECHNOLOGY INC.

1225 Broken Sound Pkwy. NW, Ste. D
Boca Raton, FL 33487-3533
561-994-0500

airturbinetools.com

Category: MACHINERY, TOOLS & EQUIPMENT

Entry on Page 127

ALITRAX

41-B Charles Ulm Pl.
Brisbane, QLD 4009
Australia

+61 7 3245 6514

alitrax.com

Category: RACE TRACK EQUIPMENT

Entry on Page 148

ALLSTATE CARBURETOR

143 Brightside Ave.
Central Islip, NY 11722
631-234-8327

allcarbs.com

Category: ENGINE COMPONENTS

Entry on Page 18

ALPINESTARS

2780 W. 237th St.
Torrance, CA 90505

310-891-0222

alpinestars.com

Category: RACING COMPONENTS,
ACCESSORIES & SERVICES

Entry on Page 87

ALTRONICS INC.

1411 S. Roselle Rd.
Schaumburg, IL 60193

847-923-0002

altronicsinc.com

Category: ENGINE COMPONENTS

Entry on Page 18

ASHCROFT INC.

250 E. Main St.
Stratford, CT 06614

800-328-8258

ashcroft.com

Category: RACING COMPONENTS,
ACCESSORIES & SERVICES

Entry on Page 79

ATI PERFORMANCE PRODUCTS

6718 Whitestone Rd.
Baltimore, MD 21207
410-298-4343

atiracing.com

Category: CHASSIS, DRIVELINE & SUSPENSION

Entry on Page 60

AUTOMATIC TRANSMISSION DESIGN

W140 N10145 Fond Du Lac Ave.
Germantown, WI 53022
262-251-7777

autotransdesign.com

Category: CHASSIS, DRIVELINE & SUSPENSION

Entry on Page 60

AUTOROD CORPORATION

21 Le Valley Dr.
Englishtown, NJ 07726
732-851-5095

autorod.net

Category: RACING COMPONENTS,
ACCESSORIES & SERVICES

Entry on Page 80

AVIORACE SRL

Via dell'Artigianato 348
Vignola MO 41058
Italy

704-402-7802

aviorace.it

Category: RACING COMPONENTS,
ACCESSORIES & SERVICES

Entry on Page 87

B4 UNLIMITED

2129 Missile St.
Harvey, LA 70058
504-874-2675

springrithm.com

Category: MACHINERY, TOOLS & EQUIPMENT

Entry on Page 127

BAKER ENGINEERING LLC

17165 Power Dr.
Nunica, MI 49448

616-837-8975

bakerengineering.com

Category: ENGINE COMPONENTS

Entry on Page 9

BALLENGER MOTORSPORTS INC.

8052 Elm Dr., Ste. G
Mechanicsville, VA 23111
804-915-7201

bmotorsports.com

Category: RACING COMPONENTS,
ACCESSORIES & SERVICES

Entry on Page 87

BAT INC./MOCAL USA

7630 Matoaka Rd.
Sarasota, FL 34243
941-355-0005

batinc.net

Category: ENGINE COMPONENTS

Entry on Page 18; **Ad on Page 81**

BEHRENT'S PERFORMANCE WAREHOUSE

38 Meadow Rd.
Florida, NY 10921
845-651-7389

behrents.com

Category: ENGINE COMPONENTS

Entry on Page 18

**BELLAVER AUTOMOTIVE DIAGNOSTICS/
WDIFL RACING**

4921 Pearce Dr.
Huntington Beach, CA 92649
714-321-7075
wediditforlove.com
Category: RACING COMPONENTS,
ACCESSORIES & SERVICES
Entry on Page 88

BEND-TECH

729 Prospect Ave.
Osceola, WI 54020
715-294-2000
bend-tech.com
Category: MACHINERY, TOOLS & EQUIPMENT
Entry on Page 128

BERNHEISEL RACE CARS

1 Bordnersville Rd.
Jonestown, PA 17038
717-926-7473
bernheiselracecars.com
Category: CHASSIS, DRIVELINE & SUSPENSION
Entry on Page 60

BILL MITCHELL PRODUCTS/BMP

1726 Hibiscus Dr.
Edgewater, FL 32132
386-957-3009
billmitchellproducts.com
Category: ENGINE COMPONENTS
Entry on Page 20; **Ad on Page 133**

**BILLET CONNECTION - CLEAR VIEW
FILTRATION**

N. 7320 Regal St.
Spokane, WA 99217
509-467-7584
billetconnection.com
Category: ENGINE COMPONENTS
Entry on Page 20

BILLET SPECIALTIES

500 Shawmut Ave.
La Grange, IL 60526
708-588-0505
billetspecialties.com
Category: CHASSIS, DRIVELINE & SUSPENSION
Entry on Page 60

BKSK ENTERPRISES, INC.

503 S. Main St.
Lawrenceburg, KY 40342
502-370-7740
racetrackconnection.com
Category: RACING COMPONENTS,
ACCESSORIES & SERVICES
Entry on Page 88

BLP RACING PRODUCTS LLC

1015 W. Church St.
Orlando, FL 32805
407-422-0394
blp.com
Category: ENGINE COMPONENTS
Entry on Page 20; **Ad on Page 53**

BLUD LUBRICANTS

PO Box 27048
Scottsdale, AZ 85255
888-239-3946
bludlubricants.com
Category: RACING COMPONENTS,
ACCESSORIES & SERVICES
Entry on Page 88

BLUE DEMON WELDING PRODUCTS

3940 Stern Ave.
St. Charles, IL 60174
888-905-6737
bluedemonwelding.com
Category: MACHINERY, TOOLS & EQUIPMENT
Entry on Page 128

BOKER'S INC.

3104 Snelling Ave.
Minneapolis, MN 55406
612-729-9365
bokers.com
Category: CHASSIS, DRIVELINE & SUSPENSION
Entry on Page 60; **Ad on Page 157**

BOLTSANDNUTS.COM

3705 Lane Rd. Extension
Perry, OH 44081
440-606-6557
boltsandnuts.com
Category: MACHINERY, TOOLS & EQUIPMENT
Entry on Page 129

BOOSTANE

4179 Taylor Rd.
Batavia, OH 45103
513-265-8216
boostane.com
Category: RACING COMPONENTS,
ACCESSORIES & SERVICES
Entry on Page 89

BOOSTLINE

7201 Industrial Park Blvd.
Mentor, OH 44060
800-321-1364
boostlineproducts.com
Category: ENGINE COMPONENTS
Entry on Page 20; **Ad on Page 73**

BOSCH MOTORSPORT

38000 Hills Tech Dr.
Farmington Hills, MI 48331
248-876-1000
bosch-motorsport.com
Category: RACING COMPONENTS,
ACCESSORIES & SERVICES
Entry on Page 89

BOYCE INDUSTRIES

5377 W. 86th St.
Indianapolis, IN 46268
708-345-0455
boyceindustries.com
Category: RACING COMPONENTS,
ACCESSORIES & SERVICES
Entry on Page 89

BRILLE BATTERY LLC

6935 15th St. E., Bldg. 115
Sarasota, FL 34243-7201
941-312-5047
brillebattery.com
Category: ENGINE COMPONENTS
Entry on Page 20

BRASWELL CARBURETION

PO Box 3
Cortaro, AZ 85652
520-579-9177
braswell.com
Category: ENGINE COMPONENTS
Entry on Page 20; **Ad on Page 83**

BRIAN TOOLEY RACING

2100 Filiatreau Ln.
Bardstown, KY 40004
888-959-8865
briantooleracing.com
Category: ENGINE COMPONENTS
Entry on Page 22

BRODIX INC.

PO Box 1347
Mena, AR 71953-1347
479-394-1075
brodix.com
Category: ENGINE COMPONENTS
Entry on Page 22; **Ad on Page 23**

BUTLERBUILT MOTORSPORTS EQUIPMENT

70 Pitt School Rd. NW
Concord, NC 28027
704-784-1027
butlerbuilt.net
Category: RACING COMPONENTS,
ACCESSORIES & SERVICES
Entry on Page 90

BUZZE RACING

309 Performance Rd.
Mooresville, NC 28115
704-664-8907
buzzeracing.com
Category: CHASSIS, DRIVELINE & SUSPENSION
Entry on Page 60

C&S SPECIALTIES INC.

3528 Hwy. B
St. Charles, MO 63301
636-723-4996
candsspecialties.com
Category: ENGINE COMPONENTS
Entry on Page 22

CALLIES PERFORMANCE PRODUCTS INC.

901 S. Union St.
Fostoria, OH 44830
419-435-2711
callies.com
Category: ENGINE COMPONENTS
Entry on Page 22; **Ad on Page 41**

CALVERT RACING, INC.

4530 Runway Dr.
Lancaster, CA 93536
661-728-9600
calvertracing.com
Category: CHASSIS, DRIVELINE & SUSPENSION
Entry on Page 53; **Ads on Pages 14 & 55**

CANTON RACING PRODUCTS

232 Branford Rd.
North Branford, CT 06471
203-481-9460
cantorracingproducts.com
Category: ENGINE COMPONENTS
Entry on Page 22; **Ad on Page 136**

CARR LANE MANUFACTURING

4200 Carr Lane Ct.
St. Louis, MO 63119
314-647-6200
carrlane.com
Category: MACHINERY, TOOLS & EQUIPMENT
Entry on Page 129

CARTER AMERICAS LLC

2112 Broadway St. NE, Ste. 225
Minneapolis, MN 55413
888-501-5444
Carterbearings.co.uk
Category: CHASSIS, DRIVELINE & SUSPENSION
Entry on Page 62

CCA RACING PRODUCTS

N37W5661 Hamilton Rd.
Cedarburg, WI 53012
844-265-9898
ccaracing.com
Category: MACHINERY, TOOLS & EQUIPMENT
Entry on Page 130

CECOMP ELECTRONICS

1220 American Way
Libertyville, IL 60048
847-918-3510
cecomp.com
Category: CHASSIS, DRIVELINE & SUSPENSION
Entry on Page 62; **Ad on Page 121**

CENTROID CNC

159 Gates Rd.
Howard, PA 16841
814-353-9290
centroidcnc.com
Category: MACHINERY, TOOLS & EQUIPMENT
Entry on Page 130; **Ad on Page 87**

CHAMP PANS

6198 US Hwy. 12
Eau Claire, WI 54701
715-834-7748
champpans.com
Category: ENGINE COMPONENTS
Entry on Page 22; **Ad on Page 134**

CHAMPION OIL

1001 Golden Dr.
Osceola, MO 64776
660-890-6241
championsusechampion.com
Category: RACING COMPONENTS, ACCESSORIES & SERVICES
Entry on Page 90

CHASSIS ENGINEERING

1500 Ave. R
Riviera Beach, FL 33404
561-863-2188
chassisengineering.com
Category: CHASSIS, DRIVELINE & SUSPENSION
Entry on Page 62

CHASSISSIM TECHNOLOGIES

9 Harriet St.
Marrickville, NSW 2204
Australia
+61 425-219-375
chassissim.com
Category: RACING COMPONENTS, ACCESSORIES & SERVICES
Entry on Page 90

CHILLOUT SYSTEMS

1690 Enterprise Way, Ste. A
Marietta, GA 30067
954-406-0442
chilloutsystems.com
Category: RACING COMPONENTS, ACCESSORIES & SERVICES
Entry on Page 91

COKER TIRE CO INC.

1317 Chestnut St.
Chattanooga, TN 37402
800-251-6336
coker.com
Category: CHASSIS, DRIVELINE & SUSPENSION
Entry on Page 62

COMEC, INC.

301 Cayuga Dr.
 Mooresville, NC 28117
800-887-6076
comecus.com
Category: MACHINERY, TOOLS & EQUIPMENT
Entry on Page 119; **Ad on Page 91**

COMP CAMS

8649 Hacks Cross Rd.
Olive Branch, MS 38654
901-795-2400
compcams.com
Category: ENGINE COMPONENTS
Entry on Page 24

COMPUTECH SYSTEMS INC.

29971 Business Center Dr.
Charlotte Hall, MD 20622
301-884-5712
computech.com
Category: RACE TRACK EQUIPMENT
Entry on Page 148; **Ad on Page 119**

CORROSION TECHNOLOGIES

2850 Industrial Ln.
Garland, TX 75041
972-271-7361
corrosionx.com
Category: RACING COMPONENTS, ACCESSORIES & SERVICES
Entry on Page 91

CP-CARRILLO INC.

1902 McGaw Ave.
Irvine, CA 92614
949-567-9000
cp-carrillo.com
Category: ENGINE COMPONENTS
Entry on Page 10; **Ad on Page 135**

CREATIVE RACING PRODUCTS, LLC

91 Willenbrock Rd.
Oxford, CT 06478
203-910-4432
creativeracing.com
Category: CHASSIS, DRIVELINE & SUSPENSION
Entry on Page 62; **Ad on Page 71**

CTECH MANUFACTURING

7501 Commerce Dr.
Weston, WI 54476
715-355-8842
ctechmanufacturing.com
Category: MACHINERY, TOOLS & EQUIPMENT
Entry on Page 131; **Ad on Page 45**

CTEK POWER INC.

5521 N. Cumberland Ave., Ut. 1104
Chicago, IL 60656
800-941-7611
smartercharger.com
Category: MACHINERY, TOOLS & EQUIPMENT
Entry on Page 131

CWT INDUSTRIES LLC

4708 S. Old Peachtree Rd., Bldg. 700
Peachtree Corners, GA 30071
800-449-1849
cwtindustries.com
Category: MACHINERY, TOOLS & EQUIPMENT
Entry on Page 132

CYLINDER HEAD ABRASIVES

9322 Brooks Ann Way
Orangevale, CA 95662
916-638-1212
ruffstuff.com
Category: MACHINERY, TOOLS & EQUIPMENT
Entry on Page 132

D-A LUBRICANT CO. INC.

801 Edwards Dr.
Lebanon, IN 46052
317-923-5321
penngrade1.com
Category: RACING COMPONENTS, ACCESSORIES & SERVICES
Entry on Page 91

DART MACHINERY LTD.

2097 Bart Ave.
Warren, MI 48091
248-362-1188
dartheads.com
Category: ENGINE COMPONENTS
Entry on Page 24; **Ad on Page 73**

DARTON SLEEVES

2380 Camino Vida Roble, Bldg. K
Carlsbad, CA 92011
760-603-9895
dartonsleeves.com
Category: ENGINE COMPONENTS
Entry on Page 24; **Ad on Page 39**

DATA HERE-TO-THERE

4943 Terwilligar Dr. NW
Edmonton, AB T6R 0G5
Canada
780-907-3231
dataheretothere.com
Category: RACING COMPONENTS,
ACCESSORIES & SERVICES
Entry on Page 92

DAYCO PRODUCTS, LLC

16000 Common Rd.
Roseville, MI 48066
248-404-6537
daycoaftermarket.com
Category: ENGINE COMPONENTS
Entry on Page 24

DAYTONA SENSORS

240 Springview Commerce Dr.
Debary, FL 32713
386-322-7390
daytona-sensors.com
Category: RACING COMPONENTS,
ACCESSORIES & SERVICES
Entry on Page 92

DAYTONA TWIN TEC

240 Springview Commerce Dr., Bldg. 1 Ste. J
Debary, FL 32713
386-304-0700
daytona-twintec.com
Category: ENGINE COMPONENTS
Entry on Page 24

DEFIANT METAL

2419 Lewisville-Clemmons Rd., Ste. 6
Clemmons, NC 27012
336-701-2731
defiantmetal.com
Category: MACHINERY, TOOLS & EQUIPMENT
Entry on Page 133

DELTA PAG

1444 30th Rd.
Astoria, NY 11102
212-203-2912
deltapag.com
Category: ENGINE COMPONENTS
Entry on Page 11

DERALE PERFORMANCE

3901 Medford St.
Los Angeles, CA 90063
323-266-3850
derale.com
Category: ENGINE COMPONENTS
Entry on Page 24

DIAMOND PISTONS

35075 Automation Dr.
Clinton Township, MI 48091
586-792-6620
diamondracing.net
Category: ENGINE COMPONENTS
Entry on Page 26; **Ad on Page 73**

DOMINATOR RACE PRODUCTS

14181 County Rd. 10-2
Lyons, OH 43533
419-923-6970
dominatorraceproducts.com
Category: CHASSIS, DRIVELINE & SUSPENSION
Entry on Page 62

EATON PERFORMANCE PRODUCTS

26101 Northwestern Hwy.
Southfield, MI 48076
800-328-3850
eatonperformance.com
Category: CHASSIS, DRIVELINE & SUSPENSION
Entry on Page 64

ECLIPSE SURFACE TECHNOLOGIES

1330 Industry Rd.
Hatfield, PA 19440
833-326-3539
eclipseblast.com
Category: MACHINERY, TOOLS & EQUIPMENT
Entry on Page 133

EDELBROCK LLC

8649 Hacks Cross Rd.
Olive Branch, MS 38654
800-416-8628
edelbrock.com
Category: ENGINE COMPONENTS
Entry on Page 26

EIDE INDUSTRIES, INC.

16215 Piuma Ave.
Cerritos, CA 90703-1528
562-402-8335
racecanopies.com
Category: RACING COMPONENTS,
ACCESSORIES & SERVICES
Entry on Page 92

ENGINE ICE - KOST USA

1000 Tennessee Ave.
Cincinnati, OH 45229
312-771-3551
engineice.com
Category: ENGINE COMPONENTS
Entry on Page 26

ENGINE PARTS GROUP INC.

4891 Independence St., Ste. 205
Wheat Ridge, CO 80033
303-424-3200
enginepro.com
Category: ENGINE COMPONENTS
Entry on Page 26

ENGINEQUEST LLC

2580 N. Commerce St.
Las Vegas, NV 89030
800-426-8771
enginequest.com
Category: ENGINE COMPONENTS
Entry on Page 26

EQ SYSTEMS

19300 Grange St.
Cassopolis, MI 49031
574-264-3437
equalizersystems.com
Category: RACING COMPONENTS,
ACCESSORIES & SERVICES
Entry on Page 93; **Ad on Page 109**

ETL PERFORMANCE PRODUCTS INC.

1717 Pennsylvania Ave.
Salem, OH 44460
234-575-7226
etlperformanceproducts.com
Category: ENGINE COMPONENTS
Entry on Page 26

EVOLVE LUBRICANTS, INC.

3895 Warren Way
Reno, NV 89509
831-630-4097
evolvelube.com
Category: RACING COMPONENTS,
ACCESSORIES & SERVICES
Entry on Page 93

EXHAUST GAS TECHNOLOGIES INC.

15642 Dupont Ave.
Chino, CA 91710-7615
909-548-8100
exhaustgas.com
Category: RACING COMPONENTS,
ACCESSORIES & SERVICES
Entry on Page 93; **Ad on Page 85**

FASS DIESEL FUEL SYSTEMS

16234 State Hwy. 0
Marthasville, MO 63357
636-433-5410
fassride.com
Category: ENGINE COMPONENTS
Entry on Page 28

FEDPRO

4520 Richmond Rd.
Cleveland, OH 44128
216-464-6440
fpcintl.com
Category: RACING COMPONENTS,
ACCESSORIES & SERVICES
Entry on Page 94

FIGSPEED, LLC

7715 Commercial Way, #100
Henderson, NV 89011
702-463-7760

figspeed.com

Category: RACING COMPONENTS,
ACCESSORIES & SERVICES

Entry on Page 94

FIRMAN POWER EQUIPMENT

8716 W. Ludlow Dr.
Peoria, AZ 85381
602-625-3688

Firmanpowerequipment.com

Category: MACHINERY, TOOLS & EQUIPMENT

Entry on Page 134

FITECH EFI

12370 Doherty St., Ste. A
Riverside, CA 92503
951-340-2624

fitechefi.com

Category: ENGINE COMPONENTS

Entry on Page 28; **Ad on Page 117**

FIVE STAR RACE CAR BODIES

PO Box 700
Twin Lakes, WI 53181-0700
262-877-2171

fivestarbodies.com

Category: CHASSIS, DRIVELINE & SUSPENSION

Entry on Page 64

FLEECE PERFORMANCE ENGINEERING

2400 Commerce Way
Pittsboro, IN 46167
317-286-3573

fleeceperformance.com

Category: ENGINE COMPONENTS

Entry on Page 28

FLIS PERFORMANCE LLC

106 Anita Ave.
Daytona Beach, FL 32114
386-256-7021

flisperformance.com

Category: RACING COMPONENTS,
ACCESSORIES & SERVICES

Entry on Page 94

FLITZ INTERNATIONAL LTD.

821 Mohr Ave.
Waterford, WI 53185
262-534-5898

flitz.com

Category: RACING COMPONENTS,
ACCESSORIES & SERVICES

Entry on Page 95

FLUIDAMPR

180 Zoar Valley Rd.
Springville, NY 14141
716-592-1000

fluidampr.com

Category: ENGINE COMPONENTS

Entry on Page 28; **Ad on Page 132**

FLUIDLOGIC

121 Sierra St.
El Segundo, CA 90245
310-725-1720

fluidlogic.com

Category: RACING COMPONENTS,
ACCESSORIES & SERVICES

Entry on Page 95

FLUIDYNE HIGH PERFORMANCE

202 Raceway Dr.
Mooresville, NC 28117
888-358-4396

fluidyne.com

Category: ENGINE COMPONENTS

Entry on Page 28

FLURO-GELENKLAGER GMBH

Siemenstrasse 13
Rosenfeld
72348

Germany

0049742893850

fluro.de

Category: CHASSIS, DRIVELINE & SUSPENSION

Entry on Page 64

FMB MACHINE

3234 S. Cleveland Massillon Rd.
Norton, OH 44203
330-571-5519

fmbmachine.com

Category: MACHINERY, TOOLS & EQUIPMENT

Entry on Page 134

FOGGIT

PO Box 777280
Henderson, NV 89002
800-283-1433

foggit.com

Category: RACING COMPONENTS,
ACCESSORIES & SERVICES

Entry on Page 95

FRAGOLA PERFORMANCE SYSTEMS

888 W. Queen St.
Southington, CT 06489

fragolaperformancesystems.com

Category: ENGINE COMPONENTS

Entry on Page 28

FTI PERFORMANCE

1815 Patterson Ave.
DeLand, FL 32724
386-736-5816

ftiperformance.com

Category: CHASSIS, DRIVELINE &
SUSPENSION

Entry on Page 54

FUEL FACTORY

4431 William Penn Hwy.
Murrysville, PA 15668
269-330-6759

fuelfactoryusa.com

Category: RACING COMPONENTS,
ACCESSORIES & SERVICES

Entry on Page 96

FUNK MOTORSPORT LTD.

25 Mount Ave.
London E4 6SY
United Kingdom
+44 0207 458 4172

funkmotorsport.com

Category: ENGINE COMPONENTS

Entry on Page 30

GET'M PERFORMANCE PRODUCTS LLC

PO Box 187
Alvaton, KY 42122
270-935-5334

getmperformance.com

Category: ENGINE COMPONENTS

Entry on Page 30

GFH INSULATION

360 Gasoline Alley
Indianapolis, IN 46222
317-241-0868

gfhinsulation.com

Category: RACING COMPONENTS,
ACCESSORIES & SERVICES

Entry on Page 96

GIANT FINISHING

600 Factory Rd.
Addison, IL 60101
708-343-6900

giantfinishing.com

Category: MACHINERY, TOOLS & EQUIPMENT

Entry on Page 120; **Ad on Page 96**

GLADIATOR PARTS WASHERS

19 Heritage Dr.
Tiffin, OH 44883
419-443-1818

arnoldmachine.com

Category: MACHINERY, TOOLS & EQUIPMENT

Entry on Page 135

GRAF GEARBOXES

2954 W. 84th St., Ut. 6
Hialeah, FL 33018
786-264-1706

grafgearboxes.com

Category: CHASSIS, DRIVELINE & SUSPENSION

Entry on Page 64

GREEN FILTER USA

2152 University Dr. Rte. 119
Mt. Braddock, PA 15465
724-430-2050

greenfilterusa.com

Category: ENGINE COMPONENTS

Entry on Page 30

H.B. FULLER/GORILLAPRO

9001 W. Fey Dr.
Frankfort, IL 60423
888-676-7763

gorillapro.com

Category: RACING COMPONENTS,
ACCESSORIES & SERVICES

Entry on Page 96

H&H SPECIALTIES

PO Box 343
2974 West Wolf Valley Rd.
Clinton, TN 37717
865-457-0509
hardblok.com
Category: ENGINE COMPONENTS
Entry on Page 30

HAGERTY

141 Rivers Edge Dr., Ste. 200
Traverse City, MI 49684
800-922-4050
hagerty.com
Category: RACING COMPONENTS,
ACCESSORIES & SERVICES
Entry on Page 97

HALTECH ENGINE MANAGEMENT SYSTEMS

17 Durian Pl.
Wetherill Park, NSW 2164 Australia
+61-2-9729-0999
haltech.com
Category: ENGINE COMPONENTS
Entry on Page 30; **Ad on Page 73**

HAMMER CONCEPTS AND DESIGNS LLC

1579 Edgewater Ln.
Clarksville, TN 37043
641-980-8332
hammerconceptsanddesigns.com
Category: CHASSIS, DRIVELINE & SUSPENSION
Entry on Page 64

HASTINGS AIR ENERGY CONTROL INC.

5555 S. Westridge Dr.
New Berlin, WI 53151-7900
262-364-0500
hastingsair.com
Category: MACHINERY, TOOLS & EQUIPMENT
Entry on Page 135

HAVEN TECHNOLOGIES INC.

873 W. Carmel Dr.
Carmel, IN 46032
317-740-0419
isotunes.com
Category: RACING COMPONENTS,
ACCESSORIES & SERVICES
Entry on Page 97

HERITAGE-CRYSTAL CLEAN

2000 Center Dr., Ste. East C300
Hoffman Estates, IL 60192
630-333-5901
crystal-clean.com
Category: MACHINERY, TOOLS & EQUIPMENT
Entry on Page 136

HOOSIER RACING TIRE

65465 SR 931
Lakeville, IN 46536
574-784-3152
hoosiertire.com
Category: CHASSIS, DRIVELINE & SUSPENSION
Entry on Page 64

HOTRODS BY HAVLIKS LLC

1625 W. Post Rd.
Cedar Rapids, IA 52404
319-826-2066
hotrodsbyhavliks.com
Category: CHASSIS, DRIVELINE & SUSPENSION
Entry on Page 66

HOWARDS CAMS & RACING COMPONENTS

280 W. 35th Ave.
Oshkosh, WI 54902
920-420-2540
howardscams.com
Category: ENGINE COMPONENTS
Entry on Page 30; **Ad on Page 124**

HOWE RACING ENTERPRISES INC.

3195 Lyle Rd.
Beaverton, MI 48612
989-435-7080
howeracing.com
Category: CHASSIS, DRIVELINE & SUSPENSION
Entry on Page 66

HP TUNERS

700 Eastwood Ln.
Buffalo Grove, IL 60089
224-900-0269
hptuners.com
Category: RACING COMPONENTS,
ACCESSORIES & SERVICES
Entry on Page 97

HPL SUPERIOR LUBRICANTS/AFIS

3 Costin Dr.
Hebron, IN 46341
219-996-3460
hploil.com
Category: ENGINE COMPONENTS
Entry on Page 32

HUTH-BEN PEARSON INTERNATIONAL LLC

260 Grant St.
Hartford, WI 53027
800-558-7808
huthbenders.com
Category: MACHINERY, TOOLS & EQUIPMENT
Entry on Page 136

HYLIFT JOHNSON

1185 E. Keating Ave.
Muskegon, MI 49442
773-487-1400
toplineauto.com
Category: ENGINE COMPONENTS
Entry on Page 32

HYPERCRAFT

1200 Towne Centre Blvd., Ste. 1152
Provo, UT 84601
720-271-7340
hypercraftusa.com
Category: ENGINE COMPONENTS
Entry on Page 32

HYPERMAX ENGINEERING

255 IL Route 72
Gilberts, IL 60136-9795
847-428-5655
gohypermax.com
Category: ENGINE COMPONENTS
Entry on Page 32; **Ad on Page 161**

IDIDIT LLC

610 S. Maumee St.
Tecumseh, MI 49286
517-424-0577
ididit.com
Category: CHASSIS, DRIVELINE & SUSPENSION
Entry on Page 66; **Ad on Page 136**

IGNITIONEERING/B.R. MOTORSPORTS

2216 E. Mineral King Ave.
Visalia, CA 93292
559-739-1515
brmotorsports.com
Category: ENGINE COMPONENTS
Entry on Page 32; **Ad on Page 25**

INDY CYLINDER HEAD INC.

1031 Cincinnati Ave.
Xenia, OH 45385
937-708-8563
indyheads.com
Category: ENGINE COMPONENTS
Entry on Page 32

INEARZ SPORT

170 N. Cypress Way
Casselberry, FL 32707
407-339-2422
inearzsport.com
Category: RACING COMPONENTS,
ACCESSORIES & SERVICES
Entry on Page 98

INNOVATIVE SPECTATOR PRODUCTS

872 Main St. SW, D-2
Gainesville, GA 30501
866-301-7223
raceceiver.com
Category: RACE TRACK EQUIPMENT
Entry on Page 147

IS MOTORSPORT

286 A Gasoline Alley
Indianapolis, IN 46222
317-244-6643
is-motorsport.com
Category: ENGINE COMPONENTS
Entry on Page 34

ISC RACERS TAPE

87 Towpath Rd.
Fairless Hills, PA 18947
215-295-2300
racerstape.com
Category: RACING COMPONENTS,
ACCESSORIES & SERVICES
Entry on Page 98

JAZ PRODUCTS INC.

1212 E. Santa Paula St.
Santa Paula, CA 93060
805-525-8800
jazproducts.com
Category: CHASSIS, DRIVELINE & SUSPENSION
Entry on Page 66; **Ad on Page 131**

JD SQUARED INC.

915 Riverview Dr.
Johnson City, TN 37601
423-979-0309
jd2.com
Category: MACHINERY, TOOLS & EQUIPMENT
Entry on Page 137

JE PISTONS

10800 Valley View St.
Cypress, CA 90630
714-898-9763
jepistons.com
Category: ENGINE COMPONENTS
Entry on Page 34; **Ad on Page 73**

JESEL INC.

1985 Cedar Bridge Ave., Ste. 2
Lakewood, NJ 08701
732-901-1800
jesel.com
Category: ENGINE COMPONENTS
Entry on Page 34; **Ad on Page 137**

JIFFY-TITE MOTORSPORTS

4437 Walden Ave.
Lancaster, NY 14086
716-681-7200
jiffy-titemotorsports.com
Category: RACING COMPONENTS,
ACCESSORIES & SERVICES
Entry on Page 98

JMS PERFORMANCE GROUP

240 Springview Commerce Dr.
Debarry, FL 32713
601-766-9424
jmschip.com
Category: ENGINE COMPONENTS
Entry on Page 12

JRI SHOCKS LLC

116 Infield Ct.
Mooresville, NC 28117
704-660-8346
jrishocks.com
Category: CHASSIS, DRIVELINE & SUSPENSION
Entry on Page 66

K1 TECHNOLOGIES

7201 Industrial Park Blvd.
Mentor, OH 44060
616-583-9700
k1technologies.com
Category: ENGINE COMPONENTS
Entry on Page 34; **Ad on Page 73**

KAISER MANUFACTURING

396 E. St. Charles Rd.
Carol Stream, IL 60188
855-919-3626
kaisermanufacturing.com
Category: MACHINERY, TOOLS & EQUIPMENT
Entry on Page 137

KATECH ENGINEERING LLC

24324 Sorrentino Ct.
Clinton Township, MI 48035
586-791-4120
katechengines.com
Category: ENGINE COMPONENTS
Entry on Page 34

KB TRAILER SALES

7670 Hub Pkwy.
Cleveland, OH 44125
216-930-5510
kbtrailersales.com
Category: RACING COMPONENTS,
ACCESSORIES & SERVICES
Entry on Page 99

KING RACING PRODUCTS

2216 E. Mineral King Ave.
Visalia, CA 93292
559-739-1515
kingracingproducts.com
Category: CHASSIS, DRIVELINE & SUSPENSION
Entry on Page 66; **Ad on Page 25**

KINSLER FUEL INJECTION INC.

1834 Thunderbird St.
Troy, MI 48084
248-362-1145
kinsler.com
Category: ENGINE COMPONENTS
Entry on Page 34; **Ad on Page 157**

KIRKEY RACING FABRICATION INC.

PO Box 445
Rooseveltown, NY 13683
800-363-4885
kirkeyracing.com
Category: RACING COMPONENTS,
ACCESSORIES & SERVICES
Entry on Page 99

KOOKS HEADERS & EXHAUST

141 Advantage Pl.
Statesville, NC 28677
704-768-2288
kooksheaders.com
Category: ENGINE COMPONENTS
Entry on Page 36

KPXA - KEN PERRY'S XTREME ARIAS

105 Shields Ct.
Markham, ON, L3R 9T5 Canada
905-475-9712
kpxa.ca
Category: ENGINE COMPONENTS
Entry on Page 36

KRJ RACE PRODUCTS

3805 Country Ln.
Brownsburg, IN 46112
317-496-6767
krjraceproducts.com
Category: RACING COMPONENTS,
ACCESSORIES & SERVICES
Entry on Page 99

LAMIN-X PROTECTIVE FILMS

478 Beasley St.
Blairsville, GA 30512
706-955-0677
lamin-x.com
Category: RACING COMPONENTS,
ACCESSORIES & SERVICES
Entry on Page 100; **Ad on Page 121**

LARSON SYSTEMS INC.

13847 Aberdine St. NE
Ham Lake, MN 55304-7689
763-780-2131
larsonsystems.com
Category: MACHINERY, TOOLS & EQUIPMENT
Entry on Page 138

LAT RACING OILS

2366 N. Glassell St., Ste. G
Orange, CA 92865
714-585-3247
latracingoils.com
Category: RACING COMPONENTS,
ACCESSORIES & SERVICES
Entry on Page 100

LATE MODEL ENGINES LLC

1930 Aldine Western Rd.
Houston, TX 77038
713-849-4505
latemodelengines.com
Category: ENGINE COMPONENTS
Entry on Page 36

LIFELINE FIRE & SAFETY SYSTEMS

4085 Pepperell Way, Ste. E
Dublin, VA 24084
540-251-2724
lifeline-fire.com
Category: RACING COMPONENTS,
ACCESSORIES & SERVICES
Entry on Page 100

LINE2LINE COATINGS

4866 White Lake Rd.
Clarkston, MI 48346
248-625-3052
line2linecoatings.com
Category: RACING COMPONENTS,
ACCESSORIES & SERVICES
Entry on Page 101; **Ad on Page 55**

LOS ANGELES SLEEVE CO. INC.

12051 Rivera Rd.
Santa Fe Springs, CA 90670
562-945-7578
lasleeve.com
Category: ENGINE COMPONENTS
Entry on Page 36

LUCAS OIL PRODUCTS

1310 E. 96th St.
Indianapolis, IN 46240
317-927-8507
lucasoil.com
Category: RACING COMPONENTS,
ACCESSORIES & SERVICES
Entry on Page 101

M & M COMPETITION ENGINES

1421 Amy Ln., Ste. A
Franklin, IN 46131
317-739-3187
mmcompetitionengines.com
Category: ENGINE COMPONENTS
Entry on Page 36

MAC'S TIE DOWNS

469059 US-95
Sagle, ID 83860
800-666-1586
macstiedowns.com
Category: RACING COMPONENTS,
ACCESSORIES & SERVICES
Entry on Page 81

MAGIDO USA INC.

231 Tiger Way
Peachtree City, GA 30269
844-462-4436
magidousa.com
Category: MACHINERY, TOOLS & EQUIPMENT
Entry on Page 121

MAHLE AFTERMARKET INC.

23030 Mahle Dr.
Farmington Hills, MI 48335
248-347-9700
mahle-aftermarket.com
Category: ENGINE COMPONENTS
Entry on Page 36; **Ad on Page 3**

MANLEY PERFORMANCE PRODUCTS INC.

1960 Swarthmore Ave.
Lakewood, NJ 08701
732-905-3366
manleyperformance.com
Category: ENGINE COMPONENTS
Entry on Page 38; **Ad on Page 73**

MARADYNE HIGH PERFORMANCE FANS

4540 W. 160th St.
Cleveland, OH 44135
216-404-7168
maradynehp.com
Category: ENGINE COMPONENTS
Entry on Page 38

MAREDUCCI MOTORSPORTS CLOTHING

Venecia 313
León, Gto. 37020 Mexico
+52 331 021 6351
maredutti.us
Category: RACING COMPONENTS,
ACCESSORIES & SERVICES
Entry on Page 101

MASTA PERFORMANCE INC.

441 Jeni Ln.
Milford, MI 48380
248-685-8710
mastaperformance.com
Category: ENGINE COMPONENTS
Entry on Page 38; **Ad on Page 57**

MASTERCAM

671 Old Post Rd.
Tolland, CT 06084
860-875-5006
mastercam.com
Category: MACHINERY, TOOLS & EQUIPMENT
Entry on Page 138

MAXIMA RACING OILS

9266 Abraham Way
Santee, CA 92071
619-449-5000
maximausa.com
Category: RACING COMPONENTS,
ACCESSORIES & SERVICES
Entry on Page 82

MAXX-D TRAILERS

7075 FM 38 N.
Brookston, TX 75421
903-784-8059
maxxdtrailers.com
Category: RACING COMPONENTS,
ACCESSORIES & SERVICES
Entry on Page 83; **Ad on Page 104**

MB QUART

851 E. Park Ave.
Libertyville, IL 60048
847-540-7700
mbquart.com
Category: RACING COMPONENTS,
ACCESSORIES & SERVICES
Entry on Page 102

MBRP LTD.

315 Old Ferguson Rd., RR #1
Huntsville, ON, P1H 2J2 Canada
888-636-7223
mbrp.com
Category: ENGINE COMPONENTS
Entry on Page 38

MCLEOD RACING

1570 Lakeview Loop
Anaheim, CA 92807
714-630-2764
mcleodracing.com
Category: CHASSIS, DRIVELINE &
SUSPENSION
Entry on Page 55

MEC CNC MACHINES

15 Cartagena
San Clemente, CA 92672
949-800-7176
meccnc.com
Category: MACHINERY, TOOLS & EQUIPMENT
Entry on Page 139

MELLING PERFORMANCE

2620 Saradan Dr.
Jackson, MI 49202
517-787-8172
melling.com
Category: ENGINE COMPONENTS
Entries on Pages 13 & 14

MILLENNIUM TECHNOLOGIES

1404 Pilgrim Rd.
Plymouth, WI 53073
920-893-5595
mt-llc.com
Category: RACING COMPONENTS,
ACCESSORIES & SERVICES
Entry on Page 102

MME MOTORSPORT

Todraz 20, 4224 Gorenja vas, Slovenia
+386 41979000
mme-motorsport.com
Category: CHASSIS, DRIVELINE &
SUSPENSION
Entry on Page 68

MOLECULE

232 Avenida Fabricante, Ut. 102
San Clemente, CA 92672
949-429-6706
moleculesports.com
Category: RACING COMPONENTS,
ACCESSORIES & SERVICES
Entry on Page 102

MONIT MOTORSPORT

PO Box 4309
Mount Maunganui, 3149, New Zealand
+64 27 359 4814
monitmotorsport.com
Category: RACING COMPONENTS,
ACCESSORIES & SERVICES
Entry on Page 103

MOTORHEAD DIGITAL

1191 Garnsey Rd.
Palmyra, NY 14522
585-766-9785
motorheaddigital.com
Category: RACING COMPONENTS,
ACCESSORIES & SERVICES
Entry on Page 103

MPI USA, INC.

119 Eastbend Ct., Ste. 20
 Mooresville, NC 28117
704-208-4344
maxpapisinc.com
Category: CHASSIS, DRIVELINE & SUSPENSION
Entry on Page 68

MYRACEPASS

PO Box 81666
Lincoln, NE 68501
402-817-4367
myracepass.com
Category: RACING COMPONENTS,
ACCESSORIES & SERVICES
Entry on Page 103

NEAL CHANCE RACING CONVERTERS

425 E. South Ave.
Cheney, KS 67025
316-542-9869
racingconverters.com
Category: CHASSIS, DRIVELINE & SUSPENSION
Entry on Page 68

NEO SYNTHETIC OIL CO.

2871 Gundry Ave.
Signal Hill, CA 90755
562-595-7208
neosyntheticoil.com
Category: RACING COMPONENTS,
ACCESSORIES & SERVICES
Entry on Page 104; **Ad on Page 9**

NEW ENGLAND GEAR POLISHING LLC

19 Mack Rd.
Middlefield, CT 06455
860-807-5513
negearpolishing.com
Category: CHASSIS, DRIVELINE & SUSPENSION
Entry on Page 68

NEXEN TIRE AMERICA

4014 Wheatley Rd.
Richfield, OH 44286
330-671-6445
nexentireusa.com
Category: CHASSIS, DRIVELINE & SUSPENSION
Entry on Page 68

NITROUS EXPRESS/SNOW PERFORMANCE

5411 Seymour Hwy.
Wichita Falls, TX 76310-1203
940-767-7694
nitrousexpress.com
Category: CHASSIS, DRIVELINE & SUSPENSION
Entry on Page 68

NORTHERN RADIATOR

2701 4th Ave. SW
Willmar, MN 56201
800-328-8900
northernradiator.com
Category: ENGINE COMPONENTS
Entry on Page 15; **Ad on Page 139**

NUKE PERFORMANCE AB

Metodvägen 10
SE-43533 Mölnlycke, Sweden
0046-763392525
nukerformance.com
Category: CHASSIS, DRIVELINE & SUSPENSION
Entry on Page 70

OPTITORQUE TECHNOLOGIES

1 Powell Ln.
Penn Yan, NY 14527
315-924-3888
optitorque.com
Category: ENGINE COMPONENTS
Entry on Page 38

P1 MANUFACTURING

PO Box 677
Rogersville, MO 65742
417-753-5174
p1mfg.com
Category: ENGINE COMPONENTS
Entry on Page 38; **Ad on Page 140**

PAC RACING SPRINGS

21200 Telegraph Rd.
Southfield, MI 48033
866-799-9417
racingsprings.com
Category: ENGINE COMPONENTS
Entry on Page 40; **Ad on Page 73**

PBM PERFORMANCE PRODUCTS

7301 Global Dr.
Louisville, KY 40258
502-937-6946
pbm-erson.com
Category: ENGINE COMPONENTS
Entry on Page 40

PERFORMANCE CBN

3487 Dunn's Ridge
Kalamazoo, MI 49006
269-217-4262
performancecbn.com
Category: MACHINERY, TOOLS & EQUIPMENT
Entry on Page 139

PERFORMANCE ENGINEERING & MANUFACTURING

425 Industrial Park Dr.
Saint Clair, MO 63077
636-629-6200
pemracing.com
Category: CHASSIS, DRIVELINE & SUSPENSION
Entry on Page 70

PERFORMANCE PLUS GLOBAL LOGISTICS

942 Hemsath Rd.
St. Charles, MO 63303
636-946-7587
pplusglobal.com
Category: RACING COMPONENTS,
ACCESSORIES & SERVICES
Entry on Page 104; **Ad on Page 129**

PERFORMANCE PLUS - THE LEADING EDGE

1511 US Hwy. 50 W.
Odin, IL 62870
618-322-7587
perfplustle.com
Category: MACHINERY, TOOLS & EQUIPMENT
Entry on Page 140

PERSONAL POSITIONING TECHNOLOGIES LLC

1655 Tech Dr.
Bay City, MI 48706
989-798-0220
personalpositioningtechnologies.com
Category: MACHINERY, TOOLS & EQUIPMENT
Entry on Page 140

PERTRONIX INC.

440 E. Arrow Hwy.
San Dimas, CA 91773-3340
909-599-5955
pertronix.com
Category: ENGINE COMPONENTS
Entry on Page 40

PETERSON FLUID SYSTEMS INC.

4045 Specialty Pl.
Longmont, CO 80504
303-287-1731
petersonfluidsys.com
Category: ENGINE COMPONENTS
Entry on Page 40; **Ad on Page 103**

PIPER CAMS

Units 5 & 6, Bowles Well Gardens
Folkestone Kent, CT19 6PQ, United Kingdom
+44 0 1303 245300
pipercams.co.uk
Category: ENGINE COMPONENTS
Entry on Page 40

PIT-PRO CUSTOM CARTS

1756 W. CR 300 S.
Greencastle, IN 46135
317-858-1830
pitprousa.com
Category: RACE TRACK EQUIPMENT
Entry on Page 148

PMAS TECHNOLOGIES LLC

402 Haven St.
Eaton Rapids, MI 48827
517-983-8537
pmas-maf.com
Category: ENGINE COMPONENTS
Entry on Page 40

POWER AUTOMEDIA

43460 Ridge Park Dr., Ste. 170
Temecula, CA 92590
951-677-2626
powerautomedia.com
Category: RACING COMPONENTS,
ACCESSORIES & SERVICES
Entry on Page 104

POWERMASTER PERFORMANCE

1833 Downs Dr.
West Chicago, IL 60185
630-957-4019
powermasterperformance.com
Category: ENGINE COMPONENTS
Entry on Page 42

PRECISION EPOXY PRODUCTS

4279 Midway Dr.
Douglasville, GA 30134
770-489-0340
precisionepoxy.com
Category: CHASSIS, DRIVELINE & SUSPENSION
Entry on Page 70

PRO ULTRASONICS

PO Box 999
Nebo, NC 28761
828-237-1735
proultrasonics.com
Category: MACHINERY, TOOLS & EQUIPMENT
Entry on Page 141

PROCHARGER SUPERCHARGER SYSTEMS

14801 W. 114th Terr.
Lenexa, KS 66215
913-338-2886
procharger.com
Category: ENGINE COMPONENTS
Entry on Page 42

PROFESSIONAL MOTORSPORTS SOLUTIONS

926 Haley St.
Kannapolis, NC 28081
704-644-0883
professionalmotorsportssolutions.com
Category: RACE TRACK EQUIPMENT
Entry on Page 148

PROGRESSION IGNITION LLC

435 Air Park Rd., Ste. B1
Edgewater, FL 32132
714-332-9990
progressionignition.com
Category: ENGINE COMPONENTS
Entry on Page 42

PRO-TINT, INC.

735 Concord Pkwy. N.
Concord, NC 28027
704-918-4520
protintshop.com
Category: RACING COMPONENTS,
ACCESSORIES & SERVICES
Entry on Page 105

PRW INDUSTRIES INC.

1722 Illinois Ave.
Perris, CA 92571
951-436-7900
prw-usa.com
Category: ENGINE COMPONENTS
Entry on Page 42

QA1

9574 217th St. W.
Lakeville, MN 55044
952-985-5675
qa1.net
Category: CHASSIS, DRIVELINE & SUSPENSION
Entry on Page 70

QMP RACING ENGINES

9530 Owensmouth Ave., Ut. 2
Chatsworth, CA 91311
818-576-0816
qmpracing.com
Category: MACHINERY, TOOLS & EQUIPMENT
Entry on Page 141

QUALCAST

1854 Air Lane Dr., Ste. 10
Nashville, TN 37210
615-777-3863
qualcast.com
Category: ENGINE COMPONENTS
Entry on Page 42; **Ad on Page 110**

QUARTER MASTER

510 Telsor Rd.
Lake Zurich, IL 60047
847-540-8999
quartermasterusa.com
Category: CHASSIS, DRIVELINE & SUSPENSION
Entry on Page 70

QUARTER-MAX CHASSIS & RACING COMPONENTS

300 N. Linwood Rd.
Galesburg, IL 61401
309-343-7575
quartermax.com
Category: CHASSIS, DRIVELINE & SUSPENSION
Entry on Page 70

QUICK PERFORMANCE

303 Sondrol Ave.
Ames, IA 50010
515-232-0126
quickperformance.com
Category: CHASSIS, DRIVELINE & SUSPENSION
Entry on Page 72

R&M RACE TRAILERS

906 E. Main St.
Cushing, OK 74023
918-225-7223
rmtrailer.com
Category: RACING COMPONENTS,
ACCESSORIES & SERVICES
Entry on Page 105

RACE ENGINE TECHNOLOGY

Whitfield House Cheddar Rd.
Wedmore Somerset, BS28 4EJ
United Kingdom
+44 1934 713957
highpowermedia.com
Category: RACING COMPONENTS,
ACCESSORIES & SERVICES
Entry on Page 105

RACE FACE BRAND DEVELOPMENT

5122 Haltata Ct.
New Port Richey, FL 34655
727-247-5597
racefacebranddevelopment.com
Category: RACING COMPONENTS,
ACCESSORIES & SERVICES
Entry on Page 106

RACE RAMPS

2003 23rd Ave. N., Ste. A
Escanaba, MI 49829
800-213-5883
raceramps.com
Category: RACING COMPONENTS,
ACCESSORIES & SERVICES
Entry on Page 84

RACE TOOLS DIRECT

PO Box 91
East Palestine, OH 44413
888-519-2099
racetoolsdirect.com
Category: MACHINERY, TOOLS & EQUIPMENT
Entry on Page 142

RACECHICK LLC

2370 Ortiz Ave.
Woodland, CA 95776
800-853-4890
racechick.com
Category: RACING COMPONENTS,
ACCESSORIES & SERVICES
Entry on Page 106

RACELOGIC USA

27260 Haggerty Rd., Ste. A2
Farmington Hills, MI 48331
248-994-9050
racelogicusa.com
Category: RACING COMPONENTS,
ACCESSORIES & SERVICES
Entry on Page 106

RACETEC PISTONS

15681 Computer Ln.
Huntington Beach, CA 92649
714-903-4362
racetecpistons.com
Category: ENGINE COMPONENTS
Entry on Page 42; **Ad on Page 138**

RACING ELECTRONICS

555 MRN Dr. NW
Concord, NC 28027
800-272-7111
racingelectronics.com
Category: RACING COMPONENTS,
ACCESSORIES & SERVICES
Entry on Page 107

RADIUM ENGINEERING LLC

14910 SE Morning Way, Ste. 103
Clackamas, OR 97015
971-783-8850
radiumauto.com
Category: CHASSIS, DRIVELINE & SUSPENSION
Entry on Page 72

RAYBESTOS POWERTRAIN LLC

711 Tech Dr.
Crawfordsville, IN 47933-1943
765-359-2554
raybestospowertrain.com
Category: CHASSIS, DRIVELINE & SUSPENSION
Entry on Page 72; **Ad on Page 159**

RED LINE SYNTHETIC OIL

6100 Egret Ct.
Benicia, CA 94510
707-745-6100
redlineoil.com
Category: ENGINE COMPONENTS
Entry on Page 44

REDLINE ACE

5403 Maplewood Dr.
Speedway, IN 46224
317-760-4903
redlineace.com
Category: RACING COMPONENTS,
ACCESSORIES & SERVICES
Entry on Page 107

REDTIDE CANOPIES

1338 W. 12040 S.
Riverton, UT 84065
801-644-3161
whatisredtide.com
Category: RACING COMPONENTS,
ACCESSORIES & SERVICES
Entry on Page 107

REM SURFACE ENGINEERING

325 W. Queen St.
Southington, CT 06489
860-621-6755
remchem.com
Category: RACING COMPONENTS,
ACCESSORIES & SERVICES
Entry on Page 108

REVMAX TORQUE CONVERTERS

4400-2 Westinghouse Blvd.
Charlotte, NC 28273
877-780-4334
revmaxconverters.com
Category: CHASSIS, DRIVELINE & SUSPENSION
Entry on Page 72; **Ad on Page 73**

ROCKET TRACK PRODUCTS/ ENVIRONMENTAL PROTECTIVE COATINGS

PO Box 8
Ostrander, OH 43061
740-363-6180
rockettrackproducts.com
Category: RACE TRACK EQUIPMENT
Entry on Page 148

ROD END SUPPLY

1128 S. Payne
Olathe, KS 66051
913-530-7536
rodendsupply.com
Category: CHASSIS, DRIVELINE & SUSPENSION
Entry on Page 72

ROWE ELECTRONICS INC.

PO Box 403
339 Hakes Dr.
Norwalk, IA 50211
515-981-5504
rowe-electronics.com
Category: RACE TRACK EQUIPMENT
Entry on Page 148

RUSEFI LLC

22 Manning Ave.
Jersey City, NJ 07304
773-414-1279
rusefi.com
Category: ENGINE COMPONENTS
Entry on Page 44

S&S DIESEL MOTORSPORT LLC

1471 W. Tipton St.
Seymour, IN 47274
812-521-0123
ssdiesel.com
Category: ENGINE COMPONENTS
Entry on Page 44

S&W RACE CARS & COMPONENTS INC.

11 Mennonite Church Rd.
Spring City, PA 19475
610-948-7303
swracecars.com
Category: CHASSIS, DRIVELINE & SUSPENSION
Entry on Page 72

SAFETY SYSTEMS INC.-FIREBOTTLE

1529 Laurel Dr.
N. Fort Myers, FL 33917
239-995-6300
firebottleracing.com
Category: RACING COMPONENTS,
ACCESSORIES & SERVICES
Entry on Page 108

SBI VALVETRAIN PRODUCTS

2108 Utopia Ave.
Nashville, TN 37211
615-248-6281
sbintl.com
Category: ENGINE COMPONENTS
Entry on Page 44

SCE GASKETS INC.

424 William Springs Rd.
Mt. Pleasant, TN 38474
661-728-9200
scegaskets.com
Category: ENGINE COMPONENTS
Entry on Page 44; **Ad on Page 134**

SCHAEFFER'S SPECIALIZED LUBRICANTS

102 Barton St.
St Louis, MO 63104
800-325-9962
schaefferoil.com
Category: RACING COMPONENTS,
ACCESSORIES & SERVICES
Entry on Page 85; **Ad on Page 2**

SCHOOL OF AUTOMOTIVE MACHINISTS & TECHNOLOGY

1911 Antoine Dr.
Houston, TX 77055
713-683-3817
samtech.edu
Category: RACING COMPONENTS,
ACCESSORIES & SERVICES
Entry on Page 108

SCHULTZ PRODUCTS

2530 Asbury Ave.
Neptune, NJ 07753
845-742-9244
schultzproducts.com
Category: CHASSIS, DRIVELINE & SUSPENSION
Entry on Page 74

SCHUMANN'S SALES & SERVICE

PO Box 128
Blue Grass, IA 52726
563-381-2416
schumannssalesandservice.com
Category: ENGINE COMPONENTS
Entry on Page 44; **Ad on Page 83**

SCORPION RACING PRODUCTS

5817 NW 44th Ave.
Ocala, FL 34482
352-512-0800
scorpionracingproducts.com
Category: ENGINE COMPONENTS
Entry on Page 46

SCOTT PERFORMANCE WIRE

124 Poplar Pointe Dr.
Mooresville, NC 28115
704-664-9700
sparkplugwires.com
Category: ENGINE COMPONENTS
Entry on Page 46; **Ad on Page 102**

SERDI CORPORATION

301-C Cayuga Dr.
Mooresville, NC 28117
800-447-3790
serdi.com
Category: MACHINERY, TOOLS & EQUIPMENT
Entry on Page 122; **Ad on Page 97**

SERVICE PRECISION GRINDING INC.

2113 State Route 31
Port Byron, NY 13140
315-776-9602
drill-grinder.com
Category: MACHINERY, TOOLS & EQUIPMENT
Entry on Page 142

SHAFTECH LTD.

237 Stanford Pkwy.
Findlay, OH 45840
419-423-1000
shaftech.com
Category: ENGINE COMPONENTS
Entry on Page 46; **Ad on Page 153**

SHAVIV USA

355 Remington Blvd.
Bolingbrook, IL 60440
630-296-0102

shaviv.com

Category: MACHINERY, TOOLS & EQUIPMENT
Entry on Page 143

SHIRT WORKS RACEWEAR

1196 Energy Dr.
Gaylord, MI 49735
989-448-8889

shirtworksracewear.com

Category: RACING COMPONENTS,
ACCESSORIES & SERVICES
Entry on Page 109

SHOCKER HITCH LLC

420 County Rd. 34 E.
Arthur, ND 58006
701-707-2666

shockerhitch.com

Category: RACING COMPONENTS,
ACCESSORIES & SERVICES
Entry on Page 109

SHOP CRANE BY GORBEL

600 Fishers Run
Victor, NY 14564
855-992-7263

shopcrane.com

Category: MACHINERY, TOOLS & EQUIPMENT
Entry on Page 143

SHURIKEN BY METRA ELECTRONICS

460 Walker St.
Holly Hill, FL 32117
386-257-2956

metraonline.com

Category: ENGINE COMPONENTS
Entry on Page 46

SILVER SPORT TRANSMISSIONS

2250 Stock Creek Blvd.
Rockford, TN 37853
865-609-8187

shiftsst.com

Category: CHASSIS, DRIVELINE &
SUSPENSION
Entry on Page 56

SLADE SHOCK TECHNOLOGY

4115 Eagleville Rd.
Fostoria, OH 44830
704-232-1127

sladeshocktechnology.com

Category: CHASSIS, DRIVELINE & SUSPENSION
Entry on Page 74

SLIDELITE LLC

2934 N. Lutheran Church Rd.
Dayton, OH 45426
937-234-3906

theoriginalslidelite.com

Category: MACHINERY, TOOLS & EQUIPMENT
Entry on Page 144

SOUTHERN ADRENALINE

200 Country Ln.
Euleless, TX 76039
817-371-2350

southernadrenaline.net

Category: RACING COMPONENTS,
ACCESSORIES & SERVICES
Entry on Page 109

SOUTHERN DRAG BOAT ASSOCIATION

PO Box 28
Burnet, TX 78611
830-385-3106

sdbaracing.com

Category: RACING COMPONENTS,
ACCESSORIES & SERVICES
Entry on Page 110

SPA PERFORMANCE

133 Byers Creek Rd., Ste. B
 Mooresville, NC 28117
980-444-0650

spaturbousa.com

Category: ENGINE COMPONENTS
Entry on Page 46

SPAL USA

1731 SE Oralabor Rd.
Ankeny, IA 50021
630-336-5614

spalusa.com

Category: ENGINE COMPONENTS
Entry on Page 46; **Ad on Page 106**

SPEEDWAY MOTORS

340 Victory Ln.
Lincoln, NE 68528
800-333-7223

speedwaymotors.com

Category: MACHINERY, TOOLS & EQUIPMENT
Entry on Page 144; **Ad on Page 127**

SPINTRIC

2890 Lopes Ln.
Loomis, CA 95650
916-652-5282

drysump.com

Category: ENGINE COMPONENTS
Entry on Page 48

SRI - STOCK CAR STEEL

122 Knob Hill Rd.
 Mooresville, NC 28117
704-664-3044

stockcarsteel.com

Category: RACING COMPONENTS,
ACCESSORIES & SERVICES
Entry on Page 110

STAUBLI CORP

PO Box 189
Duncan, SC 29334
864-433-1980

staubli.com

Category: RACING COMPONENTS,
ACCESSORIES & SERVICES
Entry on Page 110

STEINJAGER

PO Box 299
Bushnell, IL 61422
309-772-3163

steinjager.com

Category: CHASSIS, DRIVELINE & SUSPENSION
Entry on Page 74

STRANGE ENGINEERING INC.

8300 Austin Ave.
Morton Grove, IL 60053
847-663-1701

racestrange.com

Category: CHASSIS, DRIVELINE & SUSPENSION
Entry on Page 74

STROUD SAFETY INC.

4101 S. May Ave.
Oklahoma City, OK 73119
405-632-2022

stroudsafety.com

Category: RACING COMPONENTS,
ACCESSORIES & SERVICES
Entry on Page 111

SUMMIT RACING EQUIPMENT

1200 Southeast Ave.
Tallmadge, OH 44278
800-230-3030

summitracing.com

Category: MACHINERY, TOOLS & EQUIPMENT
Entry on Page 144

SUNCOAST PERFORMANCE

631 Anchors St. NW
Fort Walton Beach, FL 32548
850-864-2361

suncoastperformance.com

Category: CHASSIS, DRIVELINE & SUSPENSION
Entry on Page 57

SUNNEN PRODUCTS COMPANY

7910 Manchester Rd.
St. Louis, MO 63143
314-781-2100

sunnen.com

Category: MACHINERY, TOOLS & EQUIPMENT
Entry on Page 123

SUNSHINE METALS

3941 S. Norman St.
Wichita, KS 67215
316-218-5168

sunshinemetals.com

Category: RACING COMPONENTS,
ACCESSORIES & SERVICES
Entry on Page 111

SURGE INDUSTRIAL

300 Lena Dr.
Aurora, OH 44202
330-995-4000

surgeindustrial.com

Category: RACING COMPONENTS,
ACCESSORIES & SERVICES
Entry on Page 111

SWIFT SPRINGS USA INC

15330 Fairfield Ranch Rd., Ste. I
Chino Hills, CA 91709
909-393-8623

swiftsprings.com
Category: CHASSIS, DRIVELINE & SUSPENSION
Entry on Page 74

SYSTEM 1 FILTRATION PRODUCTS

6080 Leonard Noell Dr.
Tulare, CA 93274
559-687-1955

system1filters.com
Category: ENGINE COMPONENTS
Entry on Page 48

T&E ENTERPRISES AUTO HAULERS

PO Box 237, 80 Tobey Dr.
Herscher, IL 60941
815-426-2761

tande-racetrailers.com
Category: RACING COMPONENTS,
ACCESSORIES & SERVICES
Entry on Page 112

TECHNOCRAFT CABINETS LLC

1540 N. Main
Mt. Pleasant, TN 38474
931-379-5500

trailer cabinets.com
Category: MACHINERY, TOOLS & EQUIPMENT
Entry on Page 144

TELFER DESIGN

PO Box 4041
Sonora, CA 95370
408-813-7553

kellytelfer.com
Category: RACING COMPONENTS,
ACCESSORIES & SERVICES
Entry on Page 112

THERMO-TEC

488 US Hwy. 250 N.
Greenwich, OH 44837
419-962-4556

thermotec.com
Category: RACING COMPONENTS,
ACCESSORIES & SERVICES
Entry on Page 112; **Ad on Page 138**

THG AUTOMATION LLC

2120 E. Clay St.
Indianapolis, IN 46205
317-593-5575

thgautomation.com
Category: MACHINERY, TOOLS & EQUIPMENT
Entry on Page 144

TITAN 7 LLC

941 N. Elm St., Ut. D
Orange, CA 92867
626-823-0947

titan-7.com
Category: CHASSIS, DRIVELINE & SUSPENSION
Entry on Page 74

TITUS PERFORMANCE

9875 Adams Willett Dr.
Nanjemoy, MD 20662
301-932-9292

titusperformanceproducts.com
Category: ENGINE COMPONENTS
Entry on Page 48

TMG PERFORMANCE PRODUCTS LLC / CORSA PERFORMANCE

140 Blaze Industrial Pkwy.
Berea, OH 44017
440-891-0999

corsaperformance.com
Category: ENGINE COMPONENTS
Entry on Page 48; **Ad on Page 73**

TOP STREET PERFORMANCE

15050 Shoemaker Ave.
Santa Fe Springs, CA 90670
562-926-5858

topstreetperformance.com
Category: ENGINE COMPONENTS
Entry on Page 48; **Ad on Page 89**

TORCO INTERNATIONAL CORP.

1720 S. Carlos Ave.
Ontario, CA 91761
909-980-1495

torcousa.com
Category: RACING COMPONENTS,
ACCESSORIES & SERVICES
Entry on Page 113

TOTAL TRANSMISSIONS CHICAGO

2601 Grant Ave.
Bellwood, IL 60104
708-493-0160

totaltransmissions.com
Category: CHASSIS, DRIVELINE & SUSPENSION
Entry on Page 76; **Ad on Page 139**

TOTAL VENUE CONCEPTS

1266 E. CR Road 400 N.
Petersburg, IN 47567
419-677-3023

totalvenueconcepts.com
Category: RACE TRACK EQUIPMENT
Entry on Page 149

TOTALENERGIES

5 N. Stiles St.
Linden, NJ 07036
832-207-5529

services.us.totalenergies.com
Category: RACING COMPONENTS,
ACCESSORIES & SERVICES
Entry on Page 113

TRACKSIDE SYSTEMS

1321 Davis St. SW
Canton, OH 44706
330-754-3364

tracksidesystems.com
Category: RACE TRACK EQUIPMENT
Entry on Page 149

TRAILER ALARMS LLC

301 Main Plaza, #241
New Braunfels, TX 78130
877-604-7381

trailer-alarms.com
Category: RACING COMPONENTS,
ACCESSORIES & SERVICES
Entry on Page 113

TRANSGO PERFORMANCE

2621 Merced Ave.
South El Monte, CA 91733-1997
626-443-7451

transgo.com
Category: CHASSIS, DRIVELINE & SUSPENSION
Entry on Page 76; **Ad on Page 73**

TRANSMISSION SPECIALTIES INC.

375 Turner Industrial Way
Aston, PA 19014
610-485-9110

tsirace.com
Category: CHASSIS, DRIVELINE & SUSPENSION
Entry on Page 76; **Ad on Page 73**

TRENCHANT TECHNOLOGIES LTD.

2 Farm Close, North Lincolnshire
DN15 8SR, United Kingdom
+44 1724 897318

trenchant-tech.com
Category: RACING COMPONENTS,
ACCESSORIES & SERVICES
Entry on Page 114

TRENSOR/3FP

9781 Irvine Center Dr.
Irvine, CA 92618
949-379-6730

trensor.com
Category: RACING COMPONENTS,
ACCESSORIES & SERVICES
Entry on Page 114

TRIBODYN LUBRICANTS

PO Box 117
Mooresville, NC 28115
704-266-3577

tribodyn.com
Category: RACING COMPONENTS,
ACCESSORIES & SERVICES
Entry on Page 114; **Ad on Page 86**

TRIVINCI SYSTEMS LLC

211 Gibson St., Ste. 103 Lower Level
Leesburg, VA 20176
703-843-4235

race-keeper.com
Category: RACING COMPONENTS,
ACCESSORIES & SERVICES
Entry on Page 115

FUELING THE FUTURE OF INNOVATION



JERON PEOPLES
STRATEGY &
CORPORATE DEVELOPMENT
ROLLS-ROYCE

FUELING THE FUTURE OF INNOVATION

BUILDING A SAFER FUTURE WITH INNOVATIVE DEFENSE TECHNOLOGY. ROLLS-ROYCE ENGINEERS DEVELOP DEFENSE TECHNOLOGY FOR THE AIR FORCE, ARMY, NAVY, AND EVEN NASA. IN INDIANA, INNOVATION NEVER SLOWS DOWN.



innovatefurther.com



TUBEWORKS INC.

1506 7th St.
Riverside, CA 92507
951-784-7900
tubeworks.com
Category: CHASSIS, DRIVELINE & SUSPENSION
Entry on Page 58

TURBOSMART PTY LTD.

478 Victoria St.
Wetherill Park, NSW, 2164, Australia
909-476-2570
turbosmart.com
Category: ENGINE COMPONENTS
Entry on Page 16

TURNKEY INDUSTRIES

29710 FM 2978 Road
Magnolia, TX 77354
281-753-5951
tkind.com
Category: RACING COMPONENTS,
ACCESSORIES & SERVICES
Entry on Page 115

ULTIMATE AWNING

11534 Parkside Ln. N.
Champlin, MN 55316
612-816-9644
ultimateawning.com
Category: RACING COMPONENTS,
ACCESSORIES & SERVICES
Entry on Page 115

UNITED RACE PARTS

PO Box 5
Troutman, NC 28166
704-508-1667
unitedraceparts.com
Category: MACHINERY, TOOLS & EQUIPMENT
Entry on Page 144; **Ad on Page 132**

VALCO CINCINNATI CONSUMER

411 Circle Freeway Dr.
Cincinnati, OH 45246
513-874-6550
valco-cp.com
Category: RACING COMPONENTS,
ACCESSORIES & SERVICES
Entry on Page 116

VAN NORMAN MACHINE INDIA PVT LTD.

55 Industrial Area Phase 2
Chandigarh, 160002, India
91-99-155-44777
robinsmachines.com
Category: MACHINERY, TOOLS & EQUIPMENT
Entry on Page 145; **Ads on Pages 6, 7, 81,
& 119**

VELOCITA DRIVING SUITS

7987 Old US Hwy. 52
Lexington, NC 27295
336-764-8502
velocita-usa.com
Category: RACING COMPONENTS,
ACCESSORIES & SERVICES
Entry on Page 116

VORTECH SUPERCHARGERS

1650 Pacific Ave.
Oxnard, CA 93033
805-247-0226
vortechsuperchargers.com
Category: ENGINE COMPONENTS
Entry on Page 17; **Ad on Page 128**

VYPER ENGINEERING, LLC

2545 Larsen Rd.
Green Bay, WI 54303
920-323 9832
vyperchair.com
Category: MACHINERY, TOOLS & EQUIPMENT
Entry on Page 145

WAGNER RACE PRODUCTS

1215 Vincent Pl.
Chaska, MN 55318
952-368-6088
wagnerraceproducts.com
Category: RACING COMPONENTS,
ACCESSORIES & SERVICES
Entry on Page 116

WALTON CO.

600 New Park Ave.
West Hartford, CT 06110
860-523-5231
walmartools.com
Category: MACHINERY, TOOLS & EQUIPMENT
Entry on Page 145; **Ad on Page 130**

WEHRLI CUSTOM FABRICATION

231 Harvestore Dr.
DeKalb, IL 60115
630-277-8239
wcfab.com
Category: ENGINE COMPONENTS
Entry on Page 48; **Ad on Page 111**

WEIGH-SAFE

420 N. Geneva Rd.
Lindon, UT 84042
801-820-7020
weigh-safe.com
Category: RACING COMPONENTS,
ACCESSORIES & SERVICES
Entry on Page 117

WELDON PUMP

640 Golden Oak Pkwy.
Oakwood Village, OH 44146
440-232-2282
weldonracing.com
Category: ENGINE COMPONENTS
Entry on Page 50

WIRING SPECIALTIES

41-5E Delmar Dr.
Brookfield, CT 06804
860-799-6579
wiringspecialties.com
Category: CHASSIS, DRIVELINE & SUSPENSION
Entry on Page 76

WISECO PISTON CO. INC.

7201 Industrial Park Blvd.
Mentor, OH 44060
440-951-6600
wiseco.com
Category: ENGINE COMPONENTS
Entry on Page 50; **Ad on Page 73**

WORLD PRODUCTS

7301 Global Dr.
Louisville, KY 40258
888-317-3501
worldproducts.net
Category: ENGINE COMPONENTS
Entry on Page 50; **Ad on Page 135**

XCENTRICK INNOVATIONS LTD.

2009 20th St. S., Ste. #4
Brookings, SD 57006
330-373-8106
xcentrickinn.com
Category: ENGINE COMPONENTS
Entry on Page 50

ZAMP INC.

251 NW 13th Pl.
Meridian, ID 83642
208-506-3030
zamp-racing.com
Category: RACING COMPONENTS,
ACCESSORIES & SERVICES
Entry on Page 117

ZYCOAT

15032 W. 117th St.
Olathe, KS 66062
913-599-2600
zycoat.com
Category: RACING COMPONENTS,
ACCESSORIES & SERVICES
Entry on Page 117

PERFORMANCE INDUSTRY REPS

REPRESENTING TOP BRANDS IN THE PERFORMANCE MARKET

With over 25 years of serving the Automotive Industry, our knowledge and extensive network is second to none. Our team specializes in bringing your products out to the forefront using a variety of result driven channels that will help increase sales and brand awareness.

- Consulting Services
- Increase Product Distribution and Sales
- Help Expand Marketing Footprint via Social Media, Website Design & E-commerce, Print Ads and Co-Ops with Dealers.
- Data Entry and Analytics
- New Product Launches



AERA MEMBER **CAN** MEMBER



516-378-6100 • info@scottlewisinc.com • www.scottlewisinc.com • 994 Northern Blvd, Baldwin, NY 11510 USA

ALL-MIDWEST SALES



ADMINISTRATIVE OFFICE
16700 Hampton Chase • Strongsville, OH 44136
Office: 440-238-7390 • Cell: 216-225-4564
j.morehouse@att.net

Over 50 Years of professional representation of premier companies to all levels of distribution in the Specialty Automotive Aftermarket
www.allmidwestsales.com

KAM MARKETING

MANUFACTURERS REPRESENTATIVE
There's No Substitute for Experience & Integrity

Truck & Performance Specialists



Bernie Meyer
bernie@kammarketing.com

Our Service Area



(302) 658-7778
411 Old Baltimore Pike
Chadds Ford, PA 19317

KamMarketing.com

Team CSM

CONSIDINE SALES & MARKETING

MANUFACTURERS REPRESENTATIVES SERVING AS YOUR FIELD SALES FORCE

CALL: JIM CONSIDINE
(248) 889-7887
611 S. Milford Rd.
Highland, Michigan
jconsidine@considinesales.com

CELEBRATING **50** YEARS
Of Excellence In The Automotive Aftermarket
"AWARDED" SEMA REPS OF THE YEAR

- STREET
- RACE
- TRUCK
- OFF-ROAD
- JEEP
- FLEET

NTEA MEMBER **CAN** MEMBER

ProRep MARKETING

SERVICING THE PERFORMANCE TRUCK & DIESEL MARKETS IN PENNSYLVANIA • NEW YORK • NEW JERSEY MARYLAND • DELAWARE • NEW ENGLAND EASTERN CANADA

CONTACT: ADAM OLSON
14 MEADE LANE
ENFIELD, CT 06082
PHONE: 860.698.6022
AOLSON@PROREPMARKETING.COM

Visit Us At: [WWW.PROREPMARKETING.COM](http://www.PROREPMARKETING.COM)

50th KUNZMAN since 1971

2019 SEMA REP OF THE YEAR AWARD (7 TIME RECIPIENT)
2019 CAN REP OF THE YEAR AWARD (2 TIME RECIPIENT)

WITH OVER 50 YEARS OF EXPERIENCE & EXPERT STAFF OF 26, WE PROVIDE SALES & MARKETING SERVICES TO ALL FACETS OF THE AUTOMOTIVE AFTERMARKET INDUSTRY.

SALES • MARKETING • ADVERTISING • BRAND MANAGEMENT • MEDIA SERVICES
DATA MANAGEMENT • PROMOTIONAL ADMINISTRATION • EVENT COVERAGE

4094 PIONEER DRIVE / WALLED LAKE, MI 48390
P 248.360.2700 F 248.360.3704 KUNZMAN.COM

MIDWEST / MINK / NORTHEAST / SOUTHEAST / WEST COAST / WESTERN CANADA

THE BUSINESS OF RACING STARTS HERE



PRI Magazine's Content Online
PRIMAG.COM

READ PRI'S MISSION STATEMENT AT PERFORMANCERACING.COM/MISSION AND SEND US YOUR FEEDBACK.

PERFORMANCE INDUSTRY REPS



BOB COOK SALES
SALES & BRAND CONSULTANTS

901-854-4632

www.bobcooksales.com

lesrudd@bobcooksales.com

NEXT LEVEL BRANDING



Ballard Allen
MARKETING, INC.

*Performance....
We build our business on it*

WWW.BALLARDALLEN.COM

Corporate Office:
711 W. 17th Street Suite F7
Costa Mesa, CA 92627
P: 949.722.7716 F: 949.722.7957

ADDITIONAL REGIONAL OFFICES SERVING YOU
LINCOLN, CA - DENVER, CO - PORTLAND, OR - PHOENIX, AZ

*We are here to service your business
in the Western 11 States and Western Canada*



**AIRHEART
SALES**

"the Performance Reps"

Jim Link Ph. 425.888.2540

Branch Offices
Ladera Ranch, CA • North Bend, WA • Portland OR,
Newport Beach, CA • El Paso, TX • Edmonton, Canada

Territory: AZ, CA, CO, ID, MT, NM, NV,
OR, TX, UT, WA, West Canada
www.airheartsales.com



Thomas Sales and Marketing

Specialists in the Performance, Automotive, Heavy Duty,
Diesel, Agricultural and Industrial Markets.

Central Office:
317-846-7024
Ron.thomasco@sbcglobal.net
www.thomassalesco.com

Indiana, Illinois,
Kentucky, Michigan, Ohio,
West Virginia,
Pennsylvania, Wisconsin.

AD INDEX

1 WAY TECHNOLOGIES	56	CHE PRECISION	93
ADVANTAGE LIFTS	61	CLARENDON SPECIALTY FASTENERS INC.	142
AIRHEART SALES	184	COLEMAN MACHINE INC.	126
ALL-MIDWEST SALES, LLC	183	COMEC INC.	91
ALS SERVICES USA CORP.	155	COMETIC GASKET INC.	85
ARE DRY SUMP SYSTEMS INC.	81	COMPUTECH SYSTEMS INC.	119
ARGO MANUFACTURING CO.	141	CONSIDINE SALES & MARKETING.	183
ARP INC.	21	CP-CARRILLO INC.	135
ATECH MOTORSPORTS	5	CREATIVE RACING PRODUCTS, LLC	71
ATL RACING FUEL CELLS	79	CROWER CAMS & EQUIPMENT CO.	31
AURORA BEARING CO.	159	CRP CANTRELL RACING PRODUCTS LLC	85
AUTOLITE	51	CTECH MANUFACTURING	45
B.R. MOTORSPORTS	25	DAIDO ENGINE BEARINGS	126
BALLARD & ALLEN MARKETING INC.	184	DARTON INTERNATIONAL INC.	39
BARNES SYSTEMS INC.	116	DEATSCHWERKS	43
BEHRENT'S PERFORMANCE WAREHOUSE.	11	DESIGN ENGINEERING INC.	13
BETA TOOLS	95	DRIVELINE STUDIOS	125
BILL MITCHELL HARDCORE RACING PRODUCTS	133	EBC BRAKES USA INC.	113
BLP RACING PRODUCTS LLC	53	EFILIVE LTD.	49
BOB COOK SALES	184	ENERGY MANUFACTURING LTD.	17
BOKER'S INC.	157	EQ SYSTEMS	109
BRASWELL CARBURETION	83	EXHAUST GAS TECHNOLOGIES INC.	85
BRODIX INC.	23	FITECH EFI	117
CALICO TECHNOLOGIES INC.	131	FLAMING RIVER INDUSTRIES INC.	94
CALLIES PERFORMANCE PRODUCTS INC.	41	FLATOUT GASKETS & FABRICATIONS.	57
CALVERT RACING SUSPENSIONS.	14,55	FLUIDAMP-R-VIBRATECH TVD	132
CAM MOTION	12	FRAM	67
CANTON RACING PRODUCTS.	136	FUEL INJECTOR CLINIC	130
CECOMP ELECTRONICS	121	GANDRUD PARTS CENTER	112
CENTROID CORP.	87	GIANT FINISHING	96
CHAMP PANS	134	GOODYEAR TIRE & RUBBER CO.	59,75

GRAND BENDING	141	NEO SYNTHETIC OIL CO. INC.	9	SCOGGIN DICKEY CHEVROLET	143
H&W MACHINE REPAIR & REBUILD INC.	143	NORTHERN RADIATOR	139	SCOTT LEWIS ASSOCIATES INC.	183
HOOSIER PATTERN INC.	100	OTR FILTERS	83	SCOTT PERFORMANCE WIRE	102
HOT SHOT'S SECRET	115	P1 MANUFACTURING	140	SCS GEARBOX INC.	114
HOWARDS CAMS/HRC	124	PACIFIC PERFORMANCE ENGINEERING	19	SERDI CORP.	97
HYPERMIX ENGINEERING INC.	161	PENSKER RACING SHOCKS	56	SETRAB USA	116
IDIDIT LLC	136	PERFORMANCE DISTRIBUTORS	10	SHAFTECH LTD.	153
INDIANA ECONOMIC DEVELOPMENT CORP.	181	PERFORMANCE FORGE INC.	53	SPAL USA	106
INTERCOMP CO.	47	PERFORMANCE PLUS GLOBAL LOGISTICS	129	SPC PERFORMANCE	88
INTERNATIONAL PRECISION MACHINING	92	PERFORMANCE TUBE BENDING INC.	15	SPECIALTY PRODUCTS DESIGN	101
ISKY RACING CAMS	27	PERMATEX INC.	98	SPEEDWAY MOTORS INC.	127
JAZ PRODUCTS INC.	131	PETERSON FLUID SYSTEMS INC.	103	STAINLESS HEADERS MANUFACTURING	112
JESEL INC.	137	PHILADELPHIA RACING PRODUCTS	153	THE ARMAKLEEN COMPANY	107
JONES RACING PRODUCTS	37	PROFORM	105	THERMO-TEC	138
KAM MARKETING INC.	183	PROREP MARKETING LLC	183	THOMAS SALES CO. INC.	184
KINSLER FUEL INJECTION INC.	157	PURE DRIVETRAIN SOLUTIONS	69	TOP STREET PERFORMANCE	89
KUNZMAN & ASSOCIATES	183	PYROTECT	108,128	TOPLINE AUTOMOTIVE ENGINEERING	187
LAMIN-X PROTECTIVE FILMS	121	QUALCAST	110	TOTAL TRANSMISSIONS CHICAGO	139
LEAR CHEMICAL RESEARCH CORP.	155	QUANTUM MACHINERY GROUP	65	TRIBODYN PERFORMANCE LUBRICANTS	86
LINE2LINE COATINGS	55	RACE WINNING BRANDS	73	TRICK FLOW SPECIALTIES	137
MAHLE AFTERMARKET INC.	3	RACETEC PISTONS	138	TURN 14 DISTRIBUTION INC.	35
MAHLE MOTORSPORTS INC.	33	RACING FORCE USA	90	TURN 2 RACING COMMUNICATIONS	14
MASTA PERFORMANCE INC.	57	RADIAL BEARING CORP.	140	UNITED ENGINE & MACHINE CO.	99
MAXX-D TRAILERS	104	RAYBESTOS POWERTRAIN LLC	159	UNITED RACE PARTS LLC	132
MAXXSONICS USA	77	RON DAVIS RACING PRODUCTS INC.	79	VAC MOTORSPORTS	136
ME RACING SERVICE AB	142	ROSS RACING PISTONS	124	VAN NORMAN MACHINE	6,7,81,119
MILODON INC.	133	ROTLER MANUFACTURING	188	VORTECH ENGINEERING INC.	128
MOCAL	81	SAMPSON	85	WALTON CO.	130
MOTIVE COMPONENTS	161	SCE GASKETS INC.	134	WEHRLI CUSTOM FABRICATION	111
MOTOR STATE DISTRIBUTING	29	SCHAEFFER MANUFACTURING CO.	2	WOOLF AIRCRAFT PRODUCTS INC.	114
NEAPCO	63	SCHUMANN'S SALES & SERVICE	83	WORLD PRODUCTS	135



PRI

CAREER CENTER

APPLY FOR JOBS

POST YOUR RESUME

GET JOB ALERTS

THE BUSINESS
OF RACING
STARTS HERE



[JOBS.PERFORMANCERACING.COM](https://jobs.performanceracing.com)

TopLine

Automotive Engineering, Inc.

Chicago, USA

TRUSTED QUALITY
AND PRECISION
SINCE 1973!

For decades, TopLine has been manufacturing and supplying O.E. spec engine parts for import cars. *It's our niche.* Along with Hylift Johnson, manufacturer of the Highest Quality Valve Lifters on the market, these brands have consistently proven that —
WE ARE COMMITTED TO YOUR SUCCESS.



**HYLIFT
JOHNSON
LIFTERS**

A Division of Topline Automotive

AMERICAN MADE FOR 70+ YEARS AND GOING STRONG!



PRISHOW
BOOTH **643**
GREEN HALL



CALL OR VISIT US ONLINE
TO SEE HOW TOPLINE CAN HELP
WITH YOUR NEXT BUILD.

800-441-1400 | TOPLINEAUTO.COM

ROTTLER H85AX

**THE
HOTTEST
SELLING
HONE ON THE
MARKET**



CONCENTRICITY, CONTROL, CONSISTENCY
EXACT CROSS HATCH ANGLE, TOP TO BOTTOM
AUTOMATIC HOLE-TO-HOLE
THREE YEAR WARRANTY

ENGINE
PERFORMANCE
EXPO
WWW.ENGINEPERFORMANCEEXPO.COM

ROTTLER

ROTLERMFG.COM 1-800-452-0534

GO TO [YOUTUBE.COM/ROTLERMFG](https://www.youtube.com/rottlermfg)
FOR A DEMO